

F · S · T

FINE SCIENCE TOOLS

2024



FINE SURGICAL INSTRUMENTS FOR RESEARCH™

LETTER FROM THE MANAGING PARTNER



Markus Gawenda
Managing Partner

**To our family of valued customers,
associates, and business partners,**

I am always reinvigorated by the release of our new catalog, as it allows us the opportunity to give appreciation to all who are integral parts of Fine Science Tools. This is also a great time for reflection and setting our sights on what is to come in 2024, an exciting year where we will be celebrating our 50th Anniversary! The journey has been outstanding and our dedication to service and support has propelled us from a very humble beginning to where we are now and where we will go in the future. It remains a pleasure to work closely with such inspiring and talented customers who are devoted to their contributions in science for all of these years and we look forward to serving you for many more years to come. FST has remained steadfast in our assurance to supplying quality instrumentation worldwide to an array of professionals and students in the Biomedical Science and Medical Device Technology industries. It is our unrelenting commitment to quality that is the hallmark of our company. Whether it is innovating new instruments to perfectly meet your exact needs or our teams finding new applications for existing FST instruments, our best information comes from you.

I introduce to you this year's catalog theme, Bubbles illustrating the delicate and precise by nature forms – characteristics which also describe our surgical instruments. A bubble is a microcosm where each individual element bends toward fulfilling its purpose with the whole, similar to our FST teams across the globe.

Resembling the designs of our instruments, bubbles appear simple but are complex encapsulation of elements that are fascinating to both children and adults with their beautiful shapes and colors. The lustrous appearance of bubbles and FST instruments alike catches the attention and curiosity of many.

In an effort to better serve our customers at the highest level and continue to offer our unwavering support, we are optimizing our sales structure and one of our first steps will be shifting operations from Canada to our devoted teams in the US and European offices. While change is inevitable there will always be a constant with our 100% satisfaction guarantee. We have formulated a smooth transition plan, which we can ensure will be seamless and considerate to our customers worldwide.

On behalf of all of Fine Science Tools I would like to thank you for your incredible support and your belief and trust in us to provide high quality surgical instruments to aid in your advancements and breakthroughs in science. Our achievements and longevity would not have been possible without your continued patronage. Fine Science Tools remains committed to being your partner in all aspects of your scientific developments and look forward to continuing our relationship with you for another 50+ years.

Thank you again for your continued support and loyalty.

Markus Gawenda

A handwritten signature in black ink that reads "M. Gawenda".

TABLE OF CONTENTS | CATALOG 2024

Letter from the Managing Partner	1
Table of Contents	2 – 3
Catalog Features	4 – 5
Company Timeline	6 – 7
Handcrafted	8 – 9
Custom Design	8
Repair Service	9
Satisfaction guaranteed	10 – 11
Quality Control	10
Scissors Test	11
Alloys & Materials	12 – 13
Maintenance and Care	14 – 17

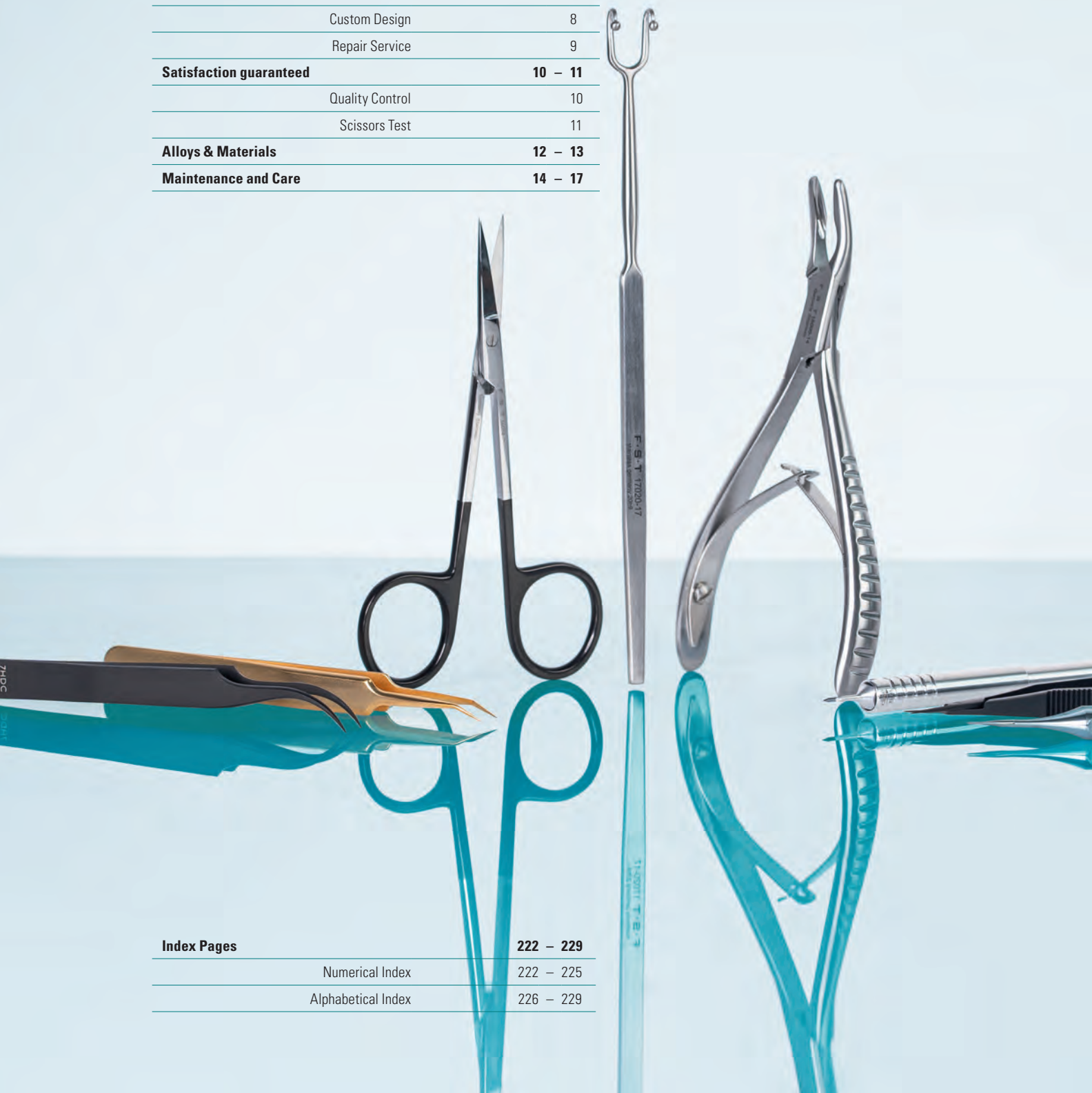

Index Pages	222 – 229
Numerical Index	222 – 225
Alphabetical Index	226 – 229

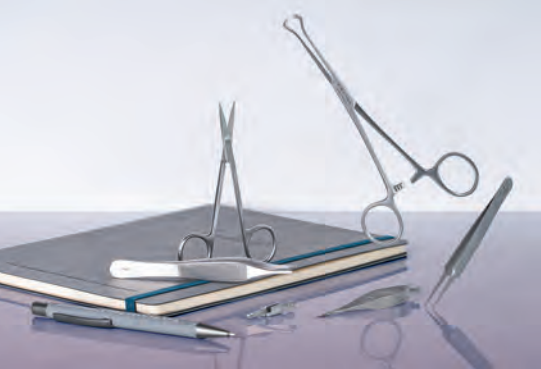

Scissors	19 – 51
Spring	19 – 30
Fine	33 – 44
Surgical	45 – 51
Bone Instruments	52 – 65
Rongeurs	52 – 55
Cutters	56 – 62
Accessories	64 – 64
Curettes & Chisels	65
Knives & Scalpels	66 – 77

Forceps/Tweezers	79 – 111
FST by Dumont	79 – 88
Fine	89 – 99
Moria	92 – 93
S&T	94
Standard	100 – 111
Hemostats	112 – 117
Vascular Instruments	118 – 127
Clamps	118 – 121
Occluders & Ligation	122 – 125
Dilation & Cannulation	124 – 127

Probes & Hooks	129 – 134
Spatulae	132 – 138
Spoons	139
Pins & Holders	140 – 141
Wound Closure	142 – 153
Needle Holders & Suture	142 – 150
Staplers, Clips & Applicators	151 – 153
Retractors	154 – 161

Animal Accessories	163 – 168
Feeding Needles	163 – 164
Animal Identification	165 – 168
Instrument Care & Accessories	169 – 180
Instrument Care	169 – 170
Sterilization & Storage	171 – 180
Surgical Accessories	181 – 184
Drill Accessories	181
Cauterizers	182 – 183
Laboratory Accessories	185 – 197
Tools	185 – 190
Magnifiers & Lens Paper	191 – 197

Student Instruments	199 – 221
Quality instruments with the student in mind	
Scissors	200 – 204
Cutter	205
Scalpel Handles	206
Forceps	207 – 212
Hemostats	213 – 216
Artery Clamps	217 – 219
Pin & Needle Holders	220
Retractors, Vessel Dilator & Clamps	221

Catalog Features

CATALOG FEATURES

To provide you with our support regarding your decision in finding the right instruments for your purpose, the product feature details are explained below.

Most Items in the catalog are shown in actual Size.

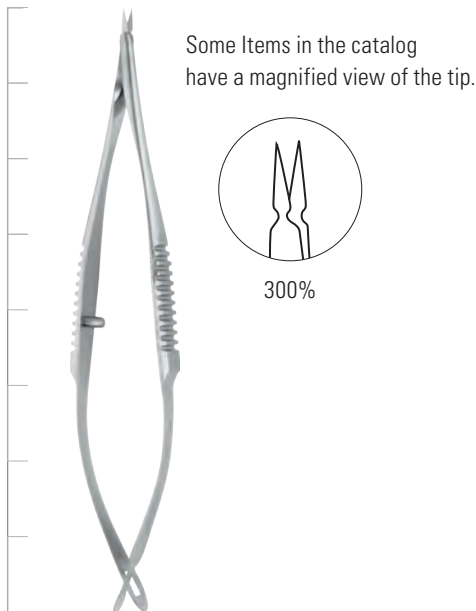

Most Items in the catalog have an illustrated view of the tip.

Straight Sharp/Sharp

length: 8 cm
Cutting edge: 2 mm
Tip Ø: 0.05 mm

No. 15000-03

Detailed Item specifications

ICONS:



Fine Science Tools has noted which items are most frequently purchased for use in a variety of surgical procedures. To find our most popular items, look for the “most popular” icon throughout the catalog.



The tips have micro serrations to ensure a better grip on tissue or other materials.



These items are not suitable for an autoclave but can be sterilized by a different method. For example: hot bead sterilization, gas sterilization, plasma sterilization or hot air sterilization. Please contact us to receive more information regarding the best preferred method for your instruments.



Fine Science Tools is proud to offer a large selection of left-handed surgical instruments to the research community. To find our left-handed instruments in this catalog, look for the “left-handed” icon on the pages below.

*Scissors: pages 33, 45 / Hemostatic Forceps: page 113
Needle Holders: pages 145 - 146 / Ligation Aid: page 125*



FST features a selection of scissors with larger than normal finger loops. Most of these loops are easily adjustable to fit larger fingers more comfortably. To find our large loop scissors please look for the “large loop” icon on the pages below.

Scissors: pages 35, 44 and 47



Our yearly selection of new instruments is based on a careful study and knowledge of our customer needs, as well as listening to their requests.

WE PROUDLY STOCK

F · S · T

by DUMONT

Fine Science Tools offers a wide selection of the latest and most popular Dumont forceps. Hand crafted in Switzerland for more than a century, these forceps are known for their consistent and uncompromised fineness.

Dumont forceps come in a wide array of styles and alloys. Below you will find detailed descriptions to help guide you in choosing the right Dumont forceps best suited for your needs.

FINDING THE DUMONT FORCEPS BEST SUITED FOR YOUR NEEDS:

Alloys	Hardness	Magnetic	Temperature resistance	Autoclavable	Advantages
Titanium	Least Hard	No	Up to 430° C	Yes	Resistant to corrosion from nitric acid, chloride, and salt water. Titanium is 40% lighter than stainless steel.
Dumoxel	Hard	No	400° C	Yes	The most popular alloy available for Dumont forceps offers the best resistance to corrosion, sulphuric environments, hydrochloric acids, and all other mineral and organic acids.
Inox	Harder	Yes	400° C	Yes	Available for most Dumont forceps. Contains chromium added to carbon steel, which results in some loss of hardness but offers good stainless qualities and resistance to corrosion.
Dumostar	Harder	No	500° C	Yes	More durable and corrosion resistant than the best stainless steels. Highly resistant to mineral and organic acids, and salt water. Dumostar lasts an average of four times longer than Dumoxel and Inox. Most cost effective alloy for laboratory use.
Carbon	Hardest	Yes	N/A	No	Extremely hard; ensuring strong tips. Easily stains and rusts without proper care. Carbon cannot be immersed in a water bath or sterilized.

Tip profiles: Dimensions vary. See each style for specific dimensions (width x thickness).

Standard	Made for high precision and consistently precise work under a microscope.
Biology	Twice as fine as "Standard Tips." Especially produced for high precision laboratory work under the microscope.
Super Fine Tips	Four times finer than the "Standard Tips." These tips are extremely delicate for the finest work under the microscope. Extra care is needed for these tips as they are very fragile.

Styles

#2	Straight forceps with wide yet fine tips, referred to as Mouse Laminectomy Forceps because of their popularity in breaking off delicate bone from mouse skulls.	#5XL	Extra Long #5 forceps.
#2AP	Epoxy coated with flat wide blunt tips.	#5/45	Tips angled at 45°.
#3	Long straight forceps with coarse tips. Popular in low magnification procedures.	#5/45C	Designed to pick up cover slips from multi-well plates.
#3C	Shorter version of #3.	#5/90	Tips angled at 90°.
#4	Similar to the #5 but with broader shanks and stronger tips.	#5AC	Self-closing Anti-Capillary forceps.
#5	Most popular style of Dumont straight forceps with fine tips which come in several styles.	#6	Sharply angled, broad tips.
#55	Similar to the #5 but with lighter shanks, giving the forceps a lighter spring action.	#7	Most popular style of Dumont curved forceps with fine tips which come in several styles.
#5CO	Similar to the #55 but with even finer shanks producing the lightest spring action and longest meeting surface of any Dumont style.	#7B	Curved serrated tips.
#5L	Medical #5 forceps with slide sleeve for a secure hold and retention.	AA	Strong broad tips.
#5SF	The finest tips ever produced by Dumont.	M	Mini forceps.
		Medical	Denotes distinctive ribbed handle to maximize grip.
		SS	Long and narrow shanks with thin tips.
		WA	One piece design with no soldering grooves allows the forceps to be thoroughly and easily cleaned preventing biofilm residue.

Timeline

F · S · T
FINE SCIENCE TOOLS
EST. 1974

FST SINCE 1974

For nearly 50 years, Fine Science Tools has been the leading distributor of precision surgical and microsurgical instruments, as well as laboratory accessories with offices in Foster City (USA) and Heidelberg (Germany) supporting and serving customers across the globe.

1974

FST established by Hans Gawenda in North Vancouver B.C., Canada.

1993

Set up European office in Heidelberg, Germany.

2003

Deployed first website to make online ordering hassle-free

2009

FST Catalog Cover wins 1st Showcase of Print and Design Excellence award. Since 2009, FST catalog covers and print Ads have won over 22 awards and are well know within the research community.

1984

Opened a business office in Foster City, California, near San Francisco.

1999

25th Anniversary of FST

1996

FST invents first and only available 0.5mm Rongeur

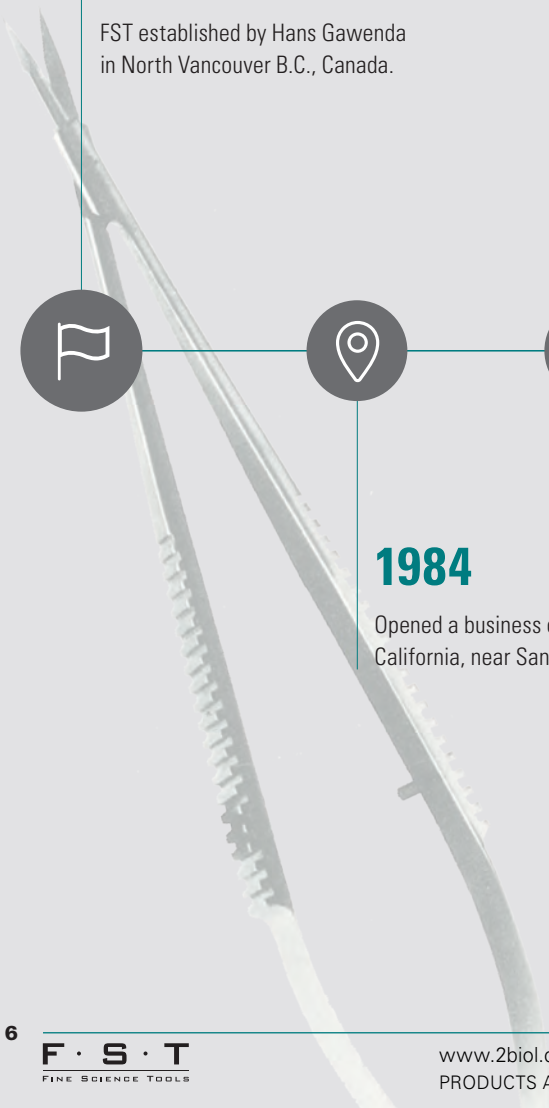

2019

Markus Gawenda joins the company
US office in Foster City, California
relocated and expanded.

2024

50th Anniversary of FST

2023

FST expands workshop
in Germany

2014

FST wins Highest Attention-Getting Ads
in Nature and Lab Animal Magazines.

2021

FST reaches 1.000
available products

2018

Launched redesigned website with zoom
feature and multiple languages for a more
immersive product experience.



Handcrafted



PRECISION THAT MAKES A MARK

Our surgical mechanics refine and perfect instruments in FST's very own workshop, this is a step that only we take in this form. This is essential for the precision and quality of each and every one of our products.

For example, our Friedman-Pearson rongeurs with tip diameters of 0.5 or 0.7 mm, both are unique in the world. Also, our spring scissors

have established themselves in the research industry and are second to none in terms of fineness.

The result: a level of quality that makes its mark - and to which we have now dedicated our own. Our new symbol "Hand-Crafted" stands for 100% guaranteed craftsmanship and instruments you can rely on in any situation.



CUSTOM DESIGN

If you have ever thought about how nice it would be to use a personalized, unique instrument, you should contact our custom design service as soon as possible.

We have the capabilities to manufacture any product to your specific requirements or to customize existing products to make them perfect for your application.



FINE SCIENCE TOOLS SERVICE

We at FST are constantly trying to improve ourselves and our service. This service includes the preparation and repair of instruments, custom-made products and individual pieces of various instruments according to customer requirements, customer-specific advice based on their application and more.

Over the years we have built up a network of partners and collaborations with well-known institutions and companies. As a result, we also offer application-specific instrument kits including complementary items from our partners.

If you are interested or have any questions, please give us a call at one of our offices.

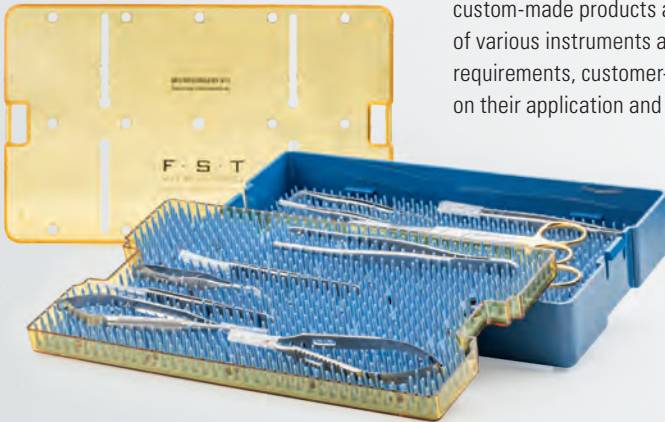

REPAIR SERVICE

In our very own workshop in Heidelberg, Germany we not only manufacture and customize specific instruments according to customer requirements, but also offer a repair service for all of our products.

Which includes:

- General repairs
- Sharpening of scissors/spring scissors
- Adjustments of forceps
- Replacement of tungsten carbide jaws
- Cleaning & reconditioning
- Replacement, if an instrument is beyond repair

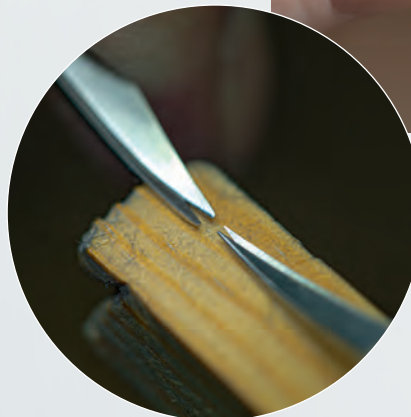

Additionally, our team is also available for repairs of your instruments which have not been purchased from FST.

Satisfaction Guarantee

QUALITY CONTROL

The high quality of Fine Science Tools surgical and microsurgical instruments is the result of our relentless attention to detail. Almost every instrument we sell is manufactured by skilled European craftsmen, designed to exacting specifications made from the finest German stainless steel alloys, and forged from the strongest, lightest materials available, and tested to ensure precision performance and ergonomics.

We are dedicated to quality control, with technicians in our German office inspecting most

FST instruments. Aside from checking instrument dimensions and specifications, we thoroughly inspect tip sharpness, cutting edges, springs, joints, and other various components. Only after passing our detailed inspections, instruments are approved and sealed with our "FST Inspected" sticker.

We are proud to guarantee all of our products with your 100% satisfaction. If, for any reason, you are not completely satisfied with your purchase, you may return it for a full refund.

100% SATISFACTION GUARANTEE

"If, for any reason, you are not completely satisfied with your purchase you may return it for a full refund."

Hans Gawenda, Founder, Fine Science Tools Inc.



F · S · T
FINE SCIENCE TOOLS

SCISSORS TEST

Does paying more for a pair of scissors really buy more value and a longer cutting life?

The picture below shows our cutting test for ring scissors based on the standards and specifications of surgical instruments in our office in Heidelberg. Each pair of scissors must perform a smooth cut without tearing or fraying the material, specifically at the fine tips. In addition, a specialized long-term test is done to identify the longevity of other featured alloys and cutting edges, tungsten carbide and ToughCut®. In this test the scissors will repeatedly cut through a continuous feed of cotton cloth and a counter keeps track of the number of cuts made

to evaluate when the scissors begin to show a decrease in cutting quality.

The results showcase the addition of added features dramatically increases the cutting life of the scissors. Most notably, the cutting life is more than doubled with the addition of ToughCut® blades and over six times longer with our CeramaCut® feature.

See the chart below for a comparison of four different scissors sold by FST.



The cutting life is more than doubled with the addition of **ToughCut** blades to stainless steel, and over six times longer with **CeramaCut** blades.

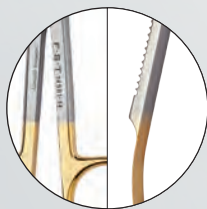

Tungsten Carbide
Lasts longer than stainless steel by: **1.9x**

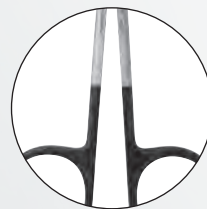

Stainless Steel with ToughCut
Lasts longer than stainless steel by: **2.3x**



Tungsten Carbide with ToughCut
Lasts longer than stainless steel by: **4.1x**

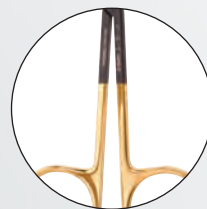

CeramaCut (Ceramic Coated Tungsten Carbide with ToughCut)
Lasts longer than stainless steel by: **6.6x**

Alloys & Materials

There are various alloys and materials which are used to produce micro surgical instruments for research with each having certain properties that would be advantageous in particular environments or applications.

We will introduce these alloys, describe their benefits and highlight unique tools for particular procedures that may be ergonomic and overall helpful for your studies and/or protocols.



ToughCut® Scissors

- Black handles
- Last approx. 2.3x longer than stainless steel
- One cutting edge has micro serrations to minimize tissue slippage
- One cutting edge has increased sharpness
- (cutting edge with a 30° instead of 15° angle)



Tungsten Carbide Instruments

- Golden handles (short gold plating)
- Last approx. 1.9x longer than stainless steel
- Is welded onto the cutting edges of scissors or tips of forceps and needles holders
- Available instruments: bone cutters, scissors, forceps, needles, needle holders, burrs

Stainless Steel Instruments

Stainless steel is an alloy, which does exactly what its name implies: stains less than ordinary steel (iron).

- Autoclavable





CeramaCut® Scissors

- Golden handles and black coating
- Last approx. 6.6x longer than stainless steel
- Cutting edges with Tungsten Carbide and Tough Cut plus ceramic coating
- Ceramic is one of the hardest materials on earth
- Reduced glare



Tungsten Carbide & ToughCut® Scissors

- Golden handles (long gold plating)
- Last approx. 4.1x longer than stainless steel
- One cutting edge has micro serrations to minimize tissue slippage
- One cutting edge has increased sharpness (cutting edge with a 30° instead of 15° angle)



Ceramic Instruments

- Ceramic coating
- Last approx. 2.3x longer than stainless steel
- Ceramic is one of the hardest materials on earth
- Reduced glare
- Available instruments: Dumont forceps and spring scissors



Titanium Instruments

- Approx. 40% lighter than stainless steel
- Softer alloy than stainless steel
- Corrosion resistance (cannot rust)
- Non-Magnetic
- High temperature resistance up to 440°C / 824°F
- Available instruments: scissors, forceps, probes, hooks, spatula, vascular clamps





Maintenance and Care

Proper care of your surgical instruments will improve their longevity and function. Below are different cleaning, sterilization, and maintenance processes to guide you through your techniques.

GENERAL

Guidelines to extend the life of your surgical instruments.

Clean and thoroughly dry your instruments as soon as possible after each use, paying special attention to joints, hinges, and anywhere there is metal to metal contact.

Handle your instruments delicately and with care.

Use your instruments for their intended purpose.

Store your instruments with tip protectors, and always place them so that they do not touch each other.



CLEANING

Fine surgical instruments should be cleaned immediately after use. Blood or saline solutions left on instruments for any length of time can quickly start corrosive action. Time, temperature, and agitation play important roles in the cleaning process. Time affects the efficiency of cleaning solutions as most are effective after a certain time period. Higher temperature cleaning solutions result in better cleaning. During manual or ultrasonic cleaning it is helpful to loosen any surgical residue. Before any of the below procedures, rinse your instruments under warm running water to remove all blood and tissue. Instruments can be cleaned manually or ultrasonically, but always:

Use a neutral pH (pH 7) cleaning solution.

Clean instruments in the open position to ensure a thorough and effective cleaning process.

Use soft textile or paper cloths, soft plastic brushes made of nylon, or water spray guns.

Do NOT use steel wool, wire brushes, or scouring pads as these are abrasive to the instruments.



MANUAL CLEANING

- ⚠ Make sure all instruments are visibly clean and free from stains, wiping them carefully to remove all blood and tissue matter.
- ⚠ Rinse instruments thoroughly with distilled water, paying close attention to joints and hinges as these areas can accumulate unwanted material.
- ⚠ Air dry your instruments completely and use a can of compressed air to blow out any water at the joints and hinges. Then store them only in clean and dry environments.



ULTRASONIC CLEANING

Ultrasonic cleaning is the most effective cleaning method. The vibrating sound waves create micron-sized bubbles in the solution that grow with the alternating pressure. When the bubbles reach a particular size, they collapse creating a force that dislodges dirt and particles, even in the smallest of crevices.

- ⚠ NOT recommended for delicate and micro instruments.
- ⚠ Follow the manufacturer's guidelines for specific instructions and cleaning cycle times.
- ⚠ Instruments should be processed for the full recommended cycle time.

Place instruments in the open position in the ultrasonic cleaner.

- Do NOT allow instruments with sharp blades to touch other instruments.
- ⚠ • Do NOT place dissimilar metals (stainless, copper, chrome plated) in the same cleaning cycle.
- Make sure all instruments are completely submerged.
- ⚠ After the ultrasonic cleaning cycle is complete, rinse instruments thoroughly to remove all ultrasonic cleaning solution.
- ⚠ Dry instruments thoroughly with a clean towel.
- ⚠ Use a spray lubricant in the hinges to minimize the risk of corrosion and maintain functionality.

STERILIZATION

It is important that instruments are free from all traces of organic or other matter prior to sterilization.

STEAM STERILIZATION/AUTOCCLAVING

The autoclave process utilizes moist heat (or steam) under pressure for sterilization. The steam used must be from distilled water and free of all impurities.

- ⚠ Lubricate all instruments that have any metal to metal interaction such as; scissors, rongeurs, needle holders, hemostats, and retractors. Do NOT use WD-40 or other industrial lubricants.

Instruments may be autoclaved individually or in sets.

- ⚠ • Individual instruments: Disposable wraps or sterilization pouches are ideal. Make sure the pouch size is sufficient for the instrument to be in an open (unlocked) position.
- Instrument sets: Open and unlock all instruments. Place the heavier instruments on the bottom of the set when two layers are needed.
- ⚠ Do NOT lock instruments during autoclaving. This will prevent the steam from reaching and sterilizing the metal to metal surfaces, and heat expansion during autoclaving can cause cracks in the hinge areas.
- ⚠ Do NOT over load the autoclave chamber as this may hinder steam penetration.
- ⚠ Place a towel on the bottom of the pan to absorb excess moisture during autoclaving. Make sure the towel has no detergent residue and is pH neutral if immersed in water.
- ⚠ At the end of the autoclave cycle (before the drying cycle) unlock the autoclave door and open it slightly. Run the dry cycle for the recommended time period by the autoclave manufacturer.

Please note: If the autoclave door is fully opened before the drying cycle, cold air will rush into the chamber, which can cause condensation on the instruments. This will result in water stains on the instruments.





HOT BEAD STERILIZATION

Recommended for speed and convenience when instrument tips or blade sterilization is required. The Hot Bead Sterilizer does not use dangerous gases, flames, or chemicals. Highlights:

- ⚠ Bench top set up.
- ⚠ Only 20 seconds of contact required to ensure your instruments are free of pathogens and microbial contaminants.
- ⚠ Beads reach temperature of 240° - 270°C (464° - 518°F) within 15-20 minutes heating time.

Please see page 172 - 173 for more information on the FST Hot Bead Sterilizers.



ETHYLENE OXIDE (ETO) STERILIZATION

This method is recommended for instruments that will not tolerate high temperatures or moisture (e.g., catheters, cannulae, etc.). This is a process consisting of 4 primary variables; gas concentration, humidity, temperature and time.

Sterilization pouches and wraps available, see pages 171, 174 and 176 - 178.



STORAGE

Surgical instruments should be properly stored in a clean and dry environment. It is highly recommended to use tip protectors and instrument cases to avoid possible damage to your instruments.

Instrument tip protectors are available, see page 180.

Instrument cases are available, see pages 178 – 180



OXIDATION (RUST)

All FST stainless steel surgical instruments are manufactured from medical grade stainless steel under strict European standards. It is very important to properly take care of your instruments to extend their lifespan.

Although stainless steel is corrosive resistant, it can still rust or stain if handled improperly. Under unfavorable conditions instruments may oxidize because stainless steel that is exposed to physical, thermal, or chemical manipulations may lose some of its stainless properties.

SCISSORS, BONE INSTRUMENTS, KNIVES & SCALPELS

Spring Scissors 19 – 30

Fine Scissors 31 – 44

Surgical Scissors 45 – 51

Bone Instruments 52 – 65

Knives & Scalpels 66 – 77



Micro Vannas

These Vannas-style spring scissors have the smallest blades ever produced. They are ideal where space is restricted and where absolute precision is demanded.



300%

Micro Vannas

The short taper is ideal for small, precise cuts.



15000-08



300%

Micro Vannas

The long taper is ideal for cutting vessel walls or when a longer cutting edge is needed.



15000-00



300%



Straight Sharp/Sharp

8 cm
Cutting edge: 2.5 mm
Tip Ø: 0.05 mm

No. 15000-08



Straight Sharp/Sharp

8 cm
Cutting edge: 2 mm
Tip Ø: 0.05 mm

No. 15000-03



Curved Sharp/Sharp

8 cm
Cutting edge: 2 mm
Tip Ø: 0.05 mm

No. 15000-04



Curved Sharp/Sharp

8 cm
Cutting edge: 2.5 mm
Tip Ø: 0.05 mm

No. 15001-08



Angled to side Sharp/Sharp

8 cm
Cutting edge: 2.5 mm
Tip Ø: 0.05 mm

No. 15002-08



Straight Sharp/Sharp

8 cm
Cutting edge: 3 mm
Tip Ø: 0.05 mm

No. 15000-00



Curved Sharp/Sharp

8 cm
Cutting edge: 3 mm
Tip Ø: 0.05 mm

No. 15000-10

Vannas-Tübingen



15003-08



**Straight
Sharp/Sharp**

8.5 cm
Cutting edge: 5 mm
Tip Ø: 0.075 mm

No. 15003-08



**Angled up
Sharp/Sharp**

9.5 cm
Cutting edge: 5 mm
Tip Ø: 0.075 mm

No. 15005-08



**Curved
Sharp/Sharp**

8.5 cm
Cutting edge: 5 mm
Tip Ø: 0.075 mm

No. 15004-08



**Angled to side
Sharp/Sharp**

8.5 cm
Cutting edge: 5 mm
Tip Ø: 0.075 mm

No. 15008-08



**Straight
Sharp/Sharp**

8.5 cm
Cutting edge: 5 mm
Tip Ø: 0.075 mm

No. 15903-08



**Curved
Sharp/Sharp**

8.5 cm
Cutting edge: 5 mm
Tip Ø: 0.075 mm

No. 15904-08

Vannas Spring Scissors High Polished

The highly polished surface makes the scissors more resistant to corrosion and easier to clean. It also prevents tissue from sticking on it while operating, it's also called non-sticky surface.



Vannas Spring Scissors Round Handle

The round handle allows an easy finger adjustment during the application. The hollow grind in the handle reduces the weight. The fine blades are tapered to give a better overview.



**Straight
Sharp/Sharp**

9 cm
Cutting edge: 5 mm
Tip Ø: 0.075 mm

No. 15403-08



**Curved
Sharp/Sharp**

9 cm
Cutting edge: 5 mm
Tip Ø: 0.075 mm

No. 15404-08

Vannas Scissors with Microserrations

Microserrated to minimize slippage.



Straight Sharp/Sharp

8.5 cm
Cutting edge: 7 mm
Tip Ø: 0.1 mm

No. 15007-08



Straight Sharp/Sharp

8.5 cm
Cutting edge: 5 mm
Tip Ø: 0.1 mm

No. 15070-08



Curved Sharp/Sharp

8.5 cm
Cutting edge: 5 mm
Tip Ø: 0.1 mm

No. 15071-08



Straight Sharp/Sharp

10.5 cm
Cutting edge: 4 mm
Tip Ø: 0.15 mm

No. 15018-10



Curved Sharp/Sharp

10.5 cm
Cutting edge: 4 mm
Tip Ø: 0.15 mm

No. 15019-10

Vannas



Miniature Vannas

Finished under high magnification, these tips are especially useful when incising vessel walls for catheter insertion.



Moria 9600



Straight Sharp/Sharp

8 cm
Cutting edge: 5 mm
Tip Ø: 0.1 mm

No. 15396-00

Moria 9601



Curved Sharp/Sharp

8 cm
Cutting edge: 5 mm
Tip Ø: 0.1 mm

No. 15396-01

Titanium Vannas



**Straight
Sharp/Sharp**

9.5 cm
Cutting edge: 5 mm
Tip Ø: 0.3 mm

No. 15610-08



**Curved
Sharp/Sharp**

9.5 cm
Cutting edge: 5 mm
Tip Ø: 0.3 mm

No. 15615-08



**Angled up
Sharp/Sharp**

9.5 cm
Cutting edge: 5 mm
Tip Ø: 0.3 mm

No. 15617-08

Cohan-Vannas

Long cutting blades for a more controlled cut.



**Straight
Sharp/Sharp**

6 cm
Cutting edge: 6 mm
Tip Ø: 0.1 mm

No. 15000-02



**Curved
Sharp/Sharp**

6.0 cm
Cutting edge: 6 mm
Tip Ø: 0.1 mm

No. 15000-01

**Straight
Blunt/Blunt**

6 cm
Cutting edge: 6 mm
Tip Ø: 0.15 mm

No. 15000-12

**Curved
Blunt/Blunt**

6 cm
Cutting edge: 6 mm
Tip Ø: 0.15 mm

No. 15000-11

ToughCut® Spring Scissors



**Straight
Sharp/Sharp**

12.5 cm
Cutting edge: 6 mm
Tip Ø: 0.3 mm

No. 15124-12



**Curved
Sharp/Sharp**

12.5 cm
Cutting edge: 6 mm
Tip Ø: 0.3 mm

No. 15123-12

Round Handled Vannas

Round handles allow easy fingertip adjustments.



**Straight
Sharp/Sharp**

12.5 cm
Cutting edge: 6 mm
Tip Ø: 0.075 mm

No. 15400-12



**Curved
Sharp/Sharp**

12.5 cm
Cutting edge: 6 mm
Tip Ø: 0.075 mm

No. 15401-12

Spring Scissors

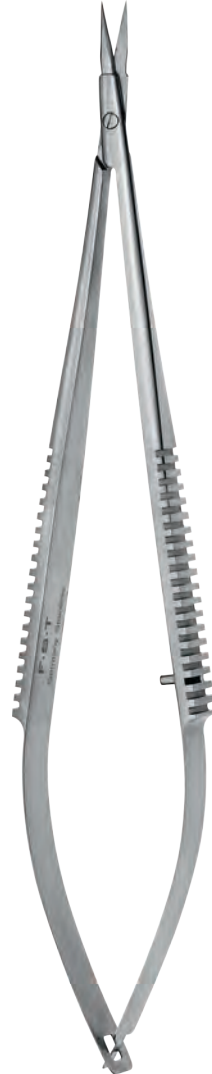

**Straight
Sharp/Sharp**

14 cm
Cutting edge: 6 mm
Tip Ø: 0.15 mm

No. 15020-15



**Curved
Sharp/Sharp**

14 cm
Cutting edge: 6 mm
Tip Ø: 0.15 mm

No. 15021-15

Ceramic Coated Spring Scissors



**Straight
Sharp/Sharp**

10 cm
Cutting edge: 7 mm
Tip Ø: 0.1 mm

No. 15750-11



**Curved
Sharp/Sharp**

10 cm
Cutting edge: 7 mm
Tip Ø: 0.1 mm

No. 15751-11

Vannas-Wolff



Vannas

Ultra long cutting edge without sacrificing tip width.



Castroviejo



Moria MC52



**Straight
Sharp/Sharp**

10 cm
Cutting edge: 7 mm
Tip Ø: 0.15 mm

No. 15370-52

Moria MC50



**Curved
Sharp/Sharp**

10 cm
Cutting edge: 7 mm
Tip Ø: 0.15 mm

No. 15370-50



**Straight
Sharp/Sharp**

8.5 cm
Cutting edge: 8 mm
Tip Ø: 0.1 mm

No. 15009-08



**Angled to side
Sharp/Sharp**

10 cm
Cutting edge: 10 mm
Tip Ø: 0.125 mm

No. 15006-09

Castroviejo with Ball Tip

Same as No. 15006-09 but with a ball tip to prevent piercing of underlying tissue.



Spring Scissors



Straight Sharp/Sharp

10 cm
Cutting edge: 8 mm
Tip Ø: 0.15 mm

No. 15024-10

Dowell



Angled to side Sharp/Ball tip

9 cm
Cutting edge: 8 mm
Tip Ø: 1.3 mm Ball

No. 15033-09



Straight Blunt/Blunt

10 cm
Cutting edge: 8 mm
Tip Ø: 0.3 mm

No. 15025-10



Curved Sharp/Sharp

10 cm
Cutting edge: 8 mm
Tip Ø: 0.15 mm

No. 15023-10



Straight Sharp/Sharp

11.5 cm
Cutting edge: 10 mm
Tip Ø: 0.1 mm

No. 15040-11



Angled up Sharp/Sharp

11.5 cm
Cutting edge: 10 mm
Tip Ø: 0.1 mm

No. 15042-11

Noyes



**Straight
Sharp/Sharp**

12 cm
Cutting edge: 14 mm
Tip Ø: 0.2 mm

No. 15012-12



**Curved
Sharp/Sharp**

12 cm
Cutting edge: 14 mm
Tip Ø: 0.2 mm

No. 15011-12

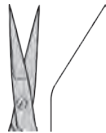

**Angled up
Sharp/Sharp**

12 cm
Cutting edge: 14 mm
Tip Ø: 0.2 mm

No. 15013-12

Tungsten Carbide Noyes

Tungsten carbide cutting edges provide long lasting sharpness.



**Straight
Sharp/Sharp**

12 cm
Cutting edge: 14 mm
Tip Ø: 0.275 mm

No. 15514-12

Castroviejo



**Curved
Sharp/Sharp**

10 cm
Cutting edge: 10 mm
Tip Ø: 0.2 mm

No. 15017-10

Ceramic Coated Titanium Castroviejo



**Straight
Sharp/Sharp**

11 cm
Cutting edge: 5 mm
Tip Ø: 0.2 mm

No. 15650-11



**Curved
Sharp/Sharp**

11 cm
Cutting edge: 5 mm
Tip Ø: 0.2 mm

No. 15651-11

Westcott



**Curved
Sharp/Sharp**

11 cm
Cutting edge: 15 mm
Tip Ø: 0.25 mm

No. 15015-11

Fine Angled Spring Scissors

These spring scissors aid in cutting tissues from various angles.



**Angled up
Sharp/Sharp**

9.5 cm
Cutting edge: 2 mm
Tip Ø: 0.1 mm

No. 15010-09



**Angled up
Sharp/Sharp**

10 cm
Cutting edge: 4 mm
Tip Ø: 0.125 mm

No. 15010-10

SPRING SCISSORS

Trident II

Special design with short handle and inner spring.



**Straight
Sharp/Sharp**

8 cm
Cutting edge: 8 mm
Tip Ø: 0.2 mm

No. 15110-08



**Angled to side
Sharp/Sharp**

8 cm
Cutting edge: 8 mm
Tip Ø: 0.2 mm

No. 15111-08

Pascheff-Wolff

Very delicate blades.

Moria



Moria MC19/B



**Angled up
Sharp/Sharp**

10.5 cm
Cutting edge: 3 mm
Tip Ø: 0.15 mm

No. 15371-92

Long Handle Spring Scissors



**Straight
Sharp/Sharp**

18.5 cm
Cutting edge: 5 mm
Tip Ø: 0.2 mm

No. 15028-18



**Curved
Sharp/Sharp**

18.5 cm
Cutting edge: 5 mm
Tip Ø: 0.2 mm

No. 15027-18



Micro Scissors

With microserrations to minimize slippage.



300%

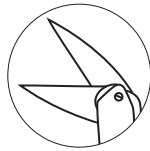

300%



**Straight
Sharp/Sharp**

14.5 cm
Cutting edge: 2.5 mm
Tip Ø: 0.175 mm

No. 15030-14



**Angled to side
Sharp/Sharp**

14.5 cm
Cutting edge: 2.5 mm
Tip Ø: 0.175 mm

No. 15031-14

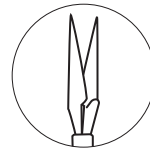

300%



**Straight
Sharp/Sharp**

14 cm
Cutting edge: 2.2 mm
Tip Ø: 0.15 mm

No. 15036-14



300%



**Angled to side
Sharp/Sharp**

14 cm
Cutting edge: 1 mm
Tip Ø: 0.1 mm

No. 15037-14

Micro Scissors

The finest blades on spring scissors. Designed for ophthalmic surgery (vitrectomy). The spring handles are made of ribbed plastic to ensure a solid grip. **Autoclavable.**

Ultra Fine Clipper Scissors II

For microscopic dissections of soft and mucous tissue. The minute fineness of the blades allows clear visualization of the tissue being dissected.



Uses:

- Removing sheath of ganglia to access neurons in aplysia.
- Cutting single nerve axons in aplysia, mollusk and snail.
- Stripping fascia off arteries and muscles.
- Ultra fine brain tissue dissection.
- Cutting of minute fiber optic strands.



**Straight
Sharp/Sharp**

10 cm
Cutting edge: 1.5 - 2 mm
Tip Ø: 0.05 - 0.08 mm
Blade shape: Triangular
0.1 mm Blade thickness

No. 15300-00

Biemer Scissors

These scissors are designed to securely cut vessels without slipping.



**Straight
Blunt/Blunt**

8.5 cm
Cutting edge: 4 mm
Tip Ø: 2 mm

No. 15032-08



**Straight
Blunt/Blunt**

13 cm
Cutting edge: 2 mm
Tip Ø: 2 mm

No. 15032-13

Extre Fine Bonn

Our finest iris scissors, best suited for microdissection under high magnification.



14084-08
14085-08



**Straight
Sharp/Sharp**

8.5 cm
Cutting edge: 10 mm

No. 14084-08



**Curved
Sharp/Sharp**

8.5 cm
Cutting edge: 10 mm

No. 14085-08



**Straight
Sharp/Blunt**

8.5 cm
Cutting edge: 10 mm

No. 14083-08



**Straight
Sharp/Sharp**

8.5 cm
Cutting edge: 10 mm

No. 14184-09



**Curved
Sharp/Sharp**

8.5 cm
Cutting edge: 10 mm

No. 14185-09

Bonn

Highly polished.



ToughCut® Bonn-Strabismus

A fusion of two light and delicate iris scissors with ToughCut cutting edges.



**Straight
Blunt/Blunt**

8.5 cm
Cutting edge: 10 mm

No. 14084-09



**Curved
Blunt/Blunt**

8.5 cm
Cutting edge: 10 mm

No. 14085-09

Hardened Fine Iris Scissors

These scissors have an anti-reflective finish to reduce glare.



14090-09



**Straight
Sharp/Sharp**

9 cm
Cutting edge: 16 mm

No. 14090-09



**Curved
Sharp/Sharp**

9 cm
Cutting edge: 16 mm

No. 14091-09

11 cm

Cutting edge: 16 mm

No. 14090-11

11 cm

Cutting edge: 16 mm

No. 14091-11

Fine Iris Scissors

Made from Martensitic stainless steel, combined with Molybdenum and Vanadium.



**Straight
Sharp/Sharp**

10.5 cm
Cutting edge: 16 mm

No. 14094-11



**Curved
Sharp/Sharp**

10.5 cm
Cutting edge: 16 mm

No. 14095-11

Iris Scissors

Delicate pattern.



14060-11



**Straight
Sharp/Sharp**

9 cm
Cutting edge: 16 mm

No. 14060-09



**Curved
Sharp/Sharp**

9 cm
Cutting edge: 16 mm

No. 14061-09



**Curved to side
Sharp/Sharp**

9 cm
Cutting edge: 16 mm

No. 14062-09



**Angled to side
Sharp/Sharp**

9 cm
Cutting edge: 16 mm

No. 14063-09

10.5 cm
Cutting edge: 16 mm

No. 14060-10

10.5 cm
Cutting edge: 16 mm

No. 14061-10

10.5 cm
Cutting edge: 16 mm

No. 14062-10

11.5 cm
Cutting edge: 16 mm

No. 14060-11

11.5 cm
Cutting edge: 16 mm

No. 14061-11

11.5 cm
Cutting edge: 18 mm

No. 14063-11



**Straight
Sharp/Sharp**

10.5 cm
Cutting edge: 18 mm

No. 14160-10



**Straight
Sharp/Sharp**

10.5 cm
Cutting edge: 18 mm

No. 14161-10

Moria Iris Scissors



Moria 4877

Moria 4878



**Straight
Sharp/Sharp**

12.5 cm
Cutting edge: 10.5 mm

No. 14370-22



**Curved
Sharp/Sharp**

10.5 cm
Cutting edge: 14 mm

No. 14370-23

Extra Narrow Iris Scissors

Extra narrow, delicate pattern. Very slim blades with gentle cutting action.



Side-view showing
extra narrow pattern

**Straight
Sharp/Sharp**

10.5 cm
Cutting edge: 16 mm

No. 14088-10

Largo Loops Scissors



**Straight
Sharp/Sharp**

10 cm
Cutting edge: 16 mm

No. 14040-10



**Curved
Sharp/Sharp**

10 cm
Cutting edge: 16 mm

No. 14041-10



**Straight
Sharp/Sharp**

12 cm
Cutting edge: 20 mm

No. 14068-12



**Curved
Sharp/Sharp**

12 cm
Cutting edge: 20 mm

No. 14069-12



**Straight
Sharp/Sharp**

12 cm
Cutting edge: 20 mm

No. 14070-12



**Curved
Sharp/Sharp**

12 cm
Cutting edge: 20 mm

No. 14071-12

Wagner



14070-12
14071-12



ToughCut®



14058-09
14058-11



**Straight
Sharp/Sharp**

9 cm
Cutting edge: 16 mm

No. 14058-09



**Curved
Sharp/Sharp**

9 cm
Cutting edge: 16 mm

No. 14059-09

11.5 cm
Cutting edge: 16 mm

No. 14058-11

11.5 cm
Cutting edge: 16 mm

No. 14059-11

Tungsten Carbide



14568-09
14568-12



**Straight
Sharp/Sharp**

9 cm
Cutting edge: 16 mm

No. 14568-09



**Curved
Sharp/Sharp**

9 cm
Cutting edge: 16 mm

No. 14569-09

11.5 cm
Cutting edge: 16 mm

No. 14568-12

11.5 cm
Cutting edge: 16 mm

No. 14569-12

ToughCut® and Tungsten Carbide



**Straight
Sharp/Sharp**

9 cm
Cutting edge: 16 mm

No. 14558-09



**Curved
Sharp/Sharp**

9 cm
Cutting edge: 16 mm

No. 14559-09

11.5 cm
Cutting edge: 16 mm

No. 14558-11

11.5 cm
Cutting edge: 16 mm

No. 14559-11

CeramaCut®

These ceramic-coated scissors are the cleanest cutting, longest lasting scissors ever produced. Utilizing the unique properties of a ceramic coating, they will last six times longer than tungsten carbide instruments and cut even better than ToughCut® scissors. The black, corrosion-resistant coating has a non-glare finish.



**Straight
Sharp/Sharp**

9 cm
Cutting edge: 16 mm

No. 14958-09



**Curved
Sharp/Sharp**

9 cm
Cutting edge: 16 mm

No. 14959-09

11.5 cm
Cutting edge: 16 mm

No. 14958-11

11.5 cm
Cutting edge: 16 mm

No. 14959-11

Fine Scissors



**Straight
Sharp/Blunt**

10 cm
Cutting edge: 17 mm

No. 14028-10



**Curved
Sharp/Blunt**

10 cm
Cutting edge: 17 mm

No. 14029-10

Lexer-Baby



**Straight
Blunt/Blunt**

10 cm
Cutting edge: 16 mm

No. 14078-10



**Curved
Blunt/Blunt**

10 cm
Cutting edge: 16 mm

No. 14079-10

Strabismus

Tungsten Carbide Strabismus



**Straight
Blunt/Blunt**

9 cm
Cutting edge: 12 mm

No. 14074-09



**Curved
Blunt/Blunt**

9 cm
Cutting edge: 12 mm

No. 14075-09



**Straight
Blunt/Blunt**

11.5 cm
Cutting edge: 20 mm

No. 14074-11



**Curved
Blunt/Blunt**

11.5 cm
Cutting edge: 20 mm

No. 14075-11



**Straight
Blunt/Blunt**

9 cm
Cutting edge: 12 mm

No. 14574-09



**Curved
Blunt/Blunt**

9 cm
Cutting edge: 12 mm

No. 14575-09



**Straight
Blunt/Blunt**

11 cm
Cutting edge: 20 mm

No. 14574-11



**Curved
Blunt/Blunt**

11 cm
Cutting edge: 20 mm

No. 14575-11

Walton

Stevens Tenotomy



**Curved
Sharp/Sharp**

9.5 cm
Cutting edge: 10 mm

No. 14077-09



**Curved
Sharp/Sharp**

10.5 cm
Cutting edge: 10 mm

No. 14077-10



**Straight
Sharp/Sharp**

11 cm
Cutting edge: 13 mm

No. 14064-11



**Curved
Sharp/Sharp**

11 cm
Cutting edge: 13 mm

No. 14065-11



**Straight
Blunt/Blunt**

11 cm
Cutting edge: 13 mm

No. 14066-11



**Curved
Blunt/Blunt**

11 cm
Cutting edge: 13 mm

No. 14067-11

LaGrange

One edge is serrated to minimize slippage of tissue during cutting.
Curved handle helps when cutting from an awkward angle.



Side-view



**Curved
Sharp/Sharp**

11.5 cm
Cutting edge: 12 mm

No. 14173-12

Shea

Transplant scissors with light and delicate pattern.



**Curved
Blunt/Blunt**

12 cm
Cutting edge: 16 mm

No. 14105-12

Dissector Scissors

Slim blades for cutting tissue.



**Angled to side
Sharp/Sharp**

10 cm
Cutting edge: 6 mm

No. 14081-09

Dissector Scissors

Similar to 14081-09, but with stronger blades for cutting fine bone.



**Angled to side
Sharp/Sharp**

10.5 cm
Cutting edge: 8 mm

No. 14082-09

Spencer Ligature

Used for cutting stitches or suture.



**Straight
Sharp/Sharp**

9 cm
Cutting edge: 16 mm

No. 14076-09

Bonn Artery

Iris scissors with one ball tip to prevent piercing of underlying tissue.



**Straight
Sharp/Ball tip**

9 cm
Cutting edge: 10 mm
1.5 mm Ball Diameter

No. 14086-09



**Straight
Sharp/Ball tip**

11.5 cm
Cutting edge: 16 mm
1.5 mm Ball Diameter

No. 14080-11

Tissue Separating Scissors

**Straight
Blunt/Blunt**

11.5 cm
Cutting edge: 16 mm

No. 14072-10

Graefe



**Angled up
Sharp/Sharp**

10.5 cm
Cutting edge: 12 mm

No. 14037-10

Adjustable Loops Fine Scissors

The finger loops can be enlarged to fit almost any size.



**Straight
Sharp/Sharp**

9.5 cm
Cutting edge: 8 mm

No. 14106-09



**Straight
Blunt/Blunt**

9.5 cm
Cutting edge: 8 mm

No. 14108-09

Kaye

These scissors have semi-sharp outer edges to better facilitate dissection.



**Curved
Blunt/Blunt**

10.5 cm
Cutting edge: 14 mm

No. 14171-10

Standard Pattern

Our standard surgical scissors are recognized for these important features:

- Excellent feel and handling capability.
- Overall execution that marks them as fine examples of German craftsmanship.



14001-12 – 14001-18



14008-14



Length (cm)	Cutting edge (mm)	Straight		
		Sharp / Sharp	Sharp / Blunt	Blunt / Blunt
12	26	No. 14002-12	No. 14001-12	No. 14000-12
13	28	No. 14002-13	No. 14001-13	No. 14000-13
14.5	30	No. 14002-14	No. 14001-14	No. 14000-14
16.5	36	No. 14002-16	No. 14001-16	No. 14000-16
18.5	40		No. 14001-18	No. 14000-18
20	44			No. 14000-20

Length (cm)	Cutting edge (mm)	Straight Sharp / Blunt
14.5	30	No. 14008-14

Length (cm)	Cutting edge (mm)	Curved		
		Sharp / Sharp	Sharp / Blunt	Blunt / Blunt
12	26	No. 14005-12	No. 14004-12	No. 14003-12
13	28	No. 14005-13	No. 14004-13	No. 14003-13
14.5	30	No. 14005-14	No. 14004-14	No. 14003-14
16.5	36	No. 14005-16	No. 14004-16	No. 14003-16
18.5	40		No. 14004-18	No. 14003-18
20	44			No. 14003-20

ToughCut® Standard Pattern

Tungsten Carbide Standard Pattern

Standard Pattern with Serrations

SCISSORS



14054-13



80% of actual size

Straight Sharp/Blunt

13 cm
Cutting edge: 28 mm

No. 14054-13



Straight Sharp/Blunt

17.5 cm
Cutting edge: 42 mm

No. 14130-17



80% of actual size

Straight Sharp/Sharp

14.5 cm
Cutting edge: 34 mm

No. 14502-14



Curved Sharp/Sharp

14.5 cm
Cutting edge: 34 mm

No. 14505-14



Straight Sharp/Blunt

14.5 cm
Cutting edge: 34 mm

No. 14501-14



Curved Sharp/Blunt

14.5 cm
Cutting edge: 34 mm

No. 14504-14



80% of actual size

Straight Sharp/Blunt

14 cm
Cutting edge: 30 mm

No. 14007-14

Standard Pattern with Large Finger Loops



80% of actual size



Straight Sharp/Blunt

14.5 cm
Cutting edge: 30 mm

No. 14101-14

Tungsten Carbide Mini-Lister



Angled to side Blunt/Blunt

9 cm
Cutting edge: 14 mm

No. 14531-09

Lister

Excellent skin cutting scissors. Longer, blunt blade prevents damaging tissue underneath skin without losing the cutting line.



80% of actual size



Angled to side Blunt/Blunt

14 cm
Cutting edge: 26 mm

No. 14131-14

Metzenbaum Baby

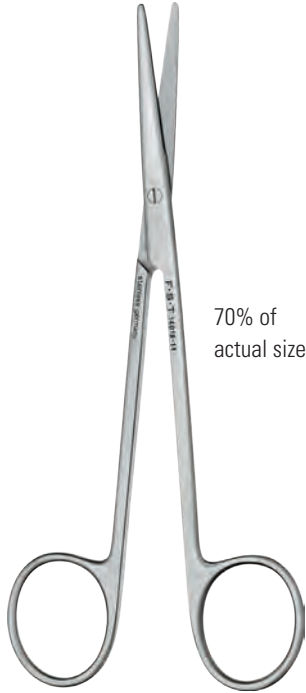

70% of actual size



**Straight
Blunt/Blunt**

13 cm
Cutting edge: 20 mm

No. 14018-13



**Curved
Blunt/Blunt**

13 cm
Cutting edge: 20 mm

No. 14019-13

14.5 cm

Cutting edge: 22 mm

No. 14018-14

14.5 cm

Cutting edge: 22 mm

No. 14019-14

18 cm

Cutting edge: 24 mm

No. 14018-18

18 cm

Cutting edge: 24 mm

No. 14019-18

Tungsten Carbide Metzenbaum Fino

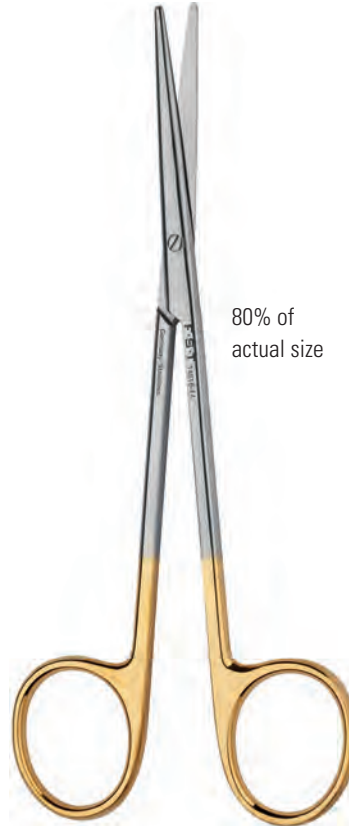

80% of actual size



**Straight
Ultra fine Blunt/
Blunt**

14.5 cm
Cutting edge: 22 mm

No. 14508-15



**Straight
Blunt/Blunt**

14.5 cm
Cutting edge: 22 mm

No. 14518-14



**Curved
Ultra fine Blunt/
Blunt**

14.5 cm
Cutting edge: 22 mm

No. 14509-15



**Curved
Blunt/Blunt**

14.5 cm
Cutting edge: 22 mm

No. 14519-14

18 cm

Cutting edge: 24 mm

No. 14518-18

18 cm

Cutting edge: 24 mm

No. 14519-18

Metzenbaum

ToughCut® Metzenbaum

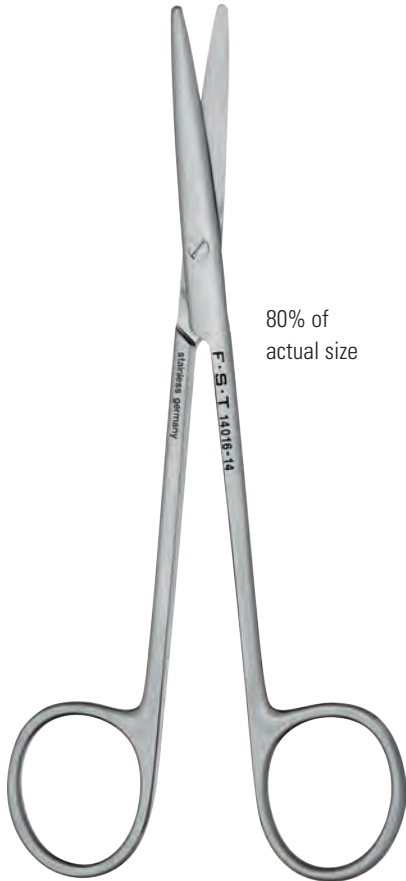

80% of actual size



80% of actual size



Straight Sharp/Blunt

14.5 cm
Cutting edge: 22 mm

No. 14024-14



Straight Blunt/Blunt

14.5 cm
Cutting edge: 22 mm

No. 14016-14



Curved Blunt/Blunt

14.5 cm
Cutting edge: 22 mm

No. 14017-14

18 cm
Cutting edge: 24 mm

No. 14016-18

18 cm
Cutting edge: 24 mm

No. 14017-18



Straight Blunt/Blunt

14.5 cm
Cutting edge: 22 mm

No. 14116-14



Curved Blunt/Blunt

14.5 cm
Cutting edge: 22 mm

No. 14117-14

18 cm
Cutting edge: 24 mm

No. 14116-18

18 cm
Cutting edge: 24 mm

No. 14117-18

Mayo

ToughCut® Mayo

Tungsten Carbide Mayo



80% of actual size



80% of actual size



14512-15 & 14512-17



80% of actual size



**Straight
Blunt/Blunt**

15 cm

Cutting edge: 28 mm

No. 14010-15



**Curved
Blunt/Blunt**

15 cm

Cutting edge: 28 mm

No. 14011-15



**Straight
Blunt/Blunt**

15 cm

Cutting edge: 28 mm

No. 14110-15



**Curved
Blunt/Blunt**

15 cm

Cutting edge: 28 mm

No. 14111-15



**Straight
Blunt/Blunt**

15 cm

Cutting edge: 28 mm

No. 14510-15



**Curved
Blunt/Blunt**

15 cm

Cutting edge: 28 mm

No. 14511-15



**Straight
Blunt/Blunt**

15 cm

Cutting edge: 28 mm

No. 14512-15

17 cm

Cutting edge: 32 mm

No. 14010-17

17 cm

Cutting edge: 32 mm

No. 14011-17

17 cm

Cutting edge: 32 mm

No. 14110-17

17 cm

Cutting edge: 32 mm

No. 14111-17

17 cm

Cutting edge: 32 mm

No. 14510-17

17 cm

Cutting edge: 32 mm

No. 14511-17

17 cm

Cutting edge: 32 mm

No. 14512-17

Mayo-Stille

Mayo-Noble

Decapitation Scissors

Stop guard at tips to prevent slippage.



80% of actual size



80% of actual size



70% of actual size



**Straight
Blunt/Blunt**

15 cm
Cutting edge: 28 mm

No. 14012-15



**Curved
Blunt/Blunt**

15 cm
Cutting edge: 28 mm

No. 14013-15



**Straight
Blunt/Blunt**

16.5 cm
Cutting edge: 30 mm

No. 14014-17



**Curved
Blunt/Blunt**

16.5 cm
Cutting edge: 30 mm

No. 14015-17



**Straight
Blunt/Blunt**

21 cm
Cutting edge: 50 mm

No. 14200-21

Friedmann-Pearson

This popular, fine-tipped rongeur is suited for delicate work. The fine-cupped jaws have been designed with a longer and slimmer approach for better visibility.



CAUTIONARY NOTE
 Cautionary note: The fine rongeur tips shown on this page are extremely fragile. Removal of material with a twisting motion can damage the tips.

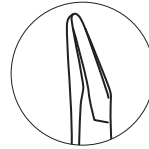

200%

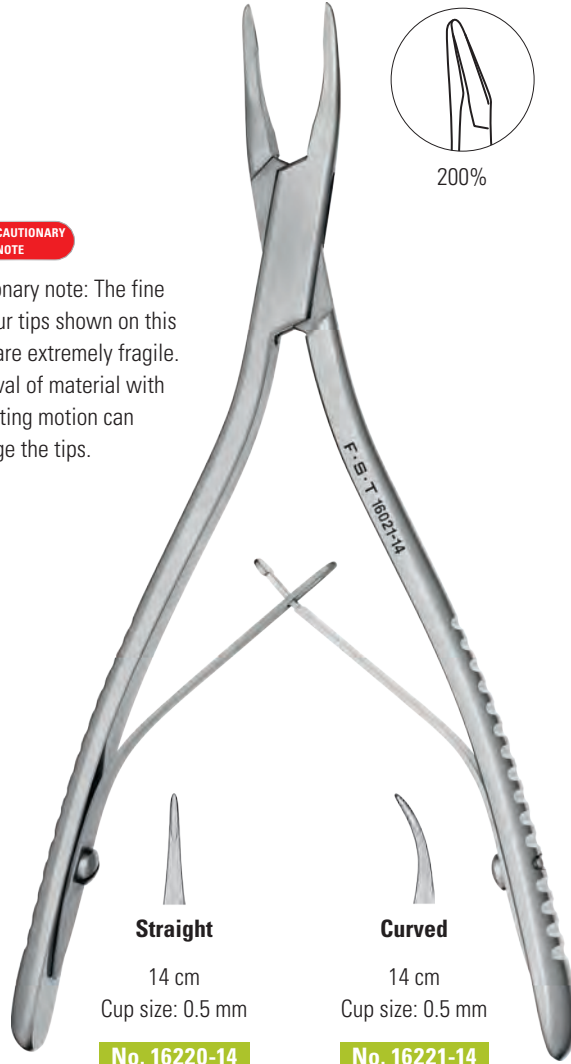

Straight

14 cm
 Cup size: 0.5 mm

No. 16220-14

Curved

14 cm
 Cup size: 0.5 mm

No. 16221-14

14 cm
 Cup size: 0.7 mm

No. 16120-14

14 cm
 Cup size: 0.7 mm

No. 16121-14

14 cm
 Cup size: 1 mm

No. 16020-14

14 cm
 Cup size: 1 mm

No. 16021-14



Pearson

Provides excellent visibility at dissection site due to its extra long and narrow approach to the fine cutting jaws. Especially suitable for larger hands.



Cautionary note: The fine rongeur tips shown on this page are extremely fragile. Removal of material with a twisting motion can damage the tips.

Shallow bend

17 cm
Cup size: 1 mm

No. 16015-17

Sharp bend

17 cm
Cup size: 1.2 mm

No. 16016-17

Luer



Curved

15 cm
Cup size: 4 mm

No. 16001-15

Baby-Beyer

Double-action rongeur with strong jaws helps relieve hand strain.

Beyer

Double-action rongeur with strong jaws helps relieve hand strain.

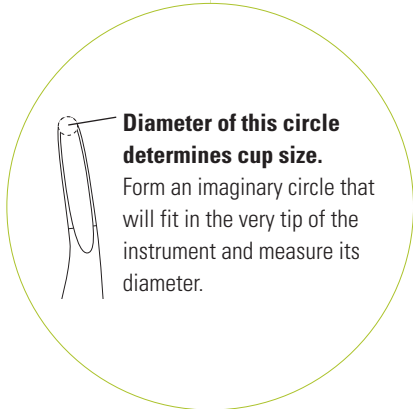

Straight
15 cm
Cup size: 2 mm
No. 16023-15

Curved
15 cm
Cup size: 2 mm
No. 16022-15



Curved
18 cm
Cup size: 2.5 mm
No. 16002-18

Friedmann

Strong and large jaws are ideal for use on the harder, outer regions of the spinal cord. Also can be used to gain access to delicate structures encased in bone.

Lempert

Extra fine jaws.



Curved
13 cm
Cup size: 2.5 mm
No. 16000-14

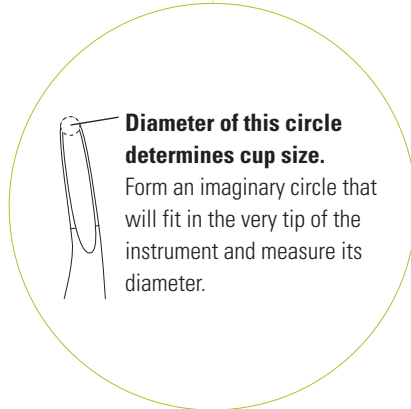

Straight
16 cm
Cup size: 2.5 mm
No. 16004-16

Curved
16 cm
Cup size: 2.5 mm
No. 16005-16

Bone Trimmers



Curved

14 cm
Cutting edge: 8 mm

No. 16109-14

Cartilage Cutter

Round cutting blades for tissue, cartilage and soft bone.



Curved

14 cm
Cutting edge: 9 mm

No. 16107-14

Dumont #15a Bone Cutter

Cutting edge on both outside and inside bevel.
Cuts suture, cartilage, bone and steel wire to 0.06 mm, and copper wire to 0.15 mm.



Angled

11.5 cm
Cutting edge: 10 mm
Jaw Opening: 2.5 mm
Hard carbon steel

No. 11215-01

Dumont #15ARW Cutter

Same structure and functionality as Item No. 11215-01 (left), but with an epoxy coating up to the cutting edge for easier care and maintenance.



Angled

11.5 cm
Cutting edge: 6 mm
Jaw Opening: 2.5 mm
Epoxy coated carbon steel

No. 11215-02

Tungsten Carbide #15AGHM Cutter



Angled

11.5 cm
Cutting edge: 10 mm
Stainless Steel handle with Tungsten Carbide tips

No. 11515-02

Bone Nipper



Angled up

11 cm
Cutting edge: 5 mm

No. 16102-11

Offset Bone Nipper

Strong jaws for cutting tough cartilage.



Angled up

10 cm
Cutting edge: 7 mm

No. 16101-10

Malleus Nipper



Straight

11 cm
Cutting edge: 9 mm

No. 16140-11



Angled Down

11 cm
Cutting edge: 9 mm

No. 16141-11



Angled up

11 cm
Cutting edge: 9 mm

No. 16142-11

Bone Cutting Spring Scissors



**Straight
Blunt/Blunt**

13 cm
Cutting edge: 12 mm

No. 16144-13

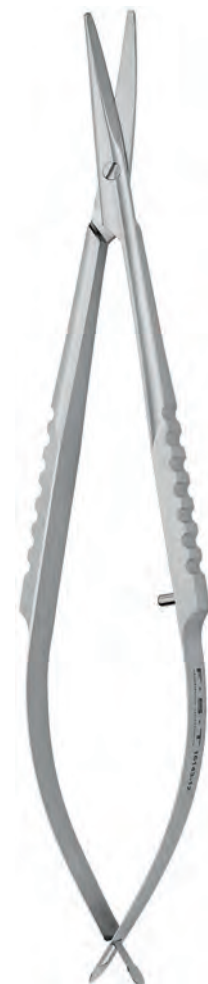

**Curved
Blunt/Blunt**

12 cm
Cutting edge: 12 mm

No. 16143-12

Delicate Bone Cutting Spring Scissors

Slim, strong blades for cutting fine bones and tissues.

CUTTERS

Littauer Bone Cutter



Straight

11 cm
Cutting edge: 15 mm

No. 16152-11



Straight

12.5 cm
Cutting edge: 17 mm

No. 16152-12



Straight

15 cm
Cutting edge: 19 mm

No. 16152-15

Beebee Bone Scissors

Very strong jaws with sharp points.



Straight

10 cm
Cutting edge: 15 mm

No. 16044-10



Tungsten Carbide Bone Scissors

Strong heavy blades for cutting bone.



Straight

12.5 cm
Cutting edge: 15 mm

No. 16030-12



Straight

16 cm
Cutting edge: 15 mm

No. 16030-16

Boehler

Bone splitting cutter with very fine tips and double action joint to relieve strain on your hand.

**Angled up**

15 cm

Cutting edge: 18 mm

No. 16130-15**Skull Flap Cutter**

One tip has a flat and narrow platform which fits between dura and skull. Other tip has sharp cutting edge. The double action joint relieves strain on your hand.

**Angled up**

14 cm

Cutting edge: 10 mm

No. 16050-15

Cleveland Cutter

Listen

Gross anatomy bone cutter.



Angled up

15 cm
Cutting edge: 14 mm

No. 16106-14

17 cm
Cutting edge: 15 mm

No. 16105-16



Straight

14 cm
Cutting edge: 20 mm

No. 16104-14

20 cm
Cutting edge: 30 mm

No. 16104-19

Bone Pliers

To peel back skull flaps.

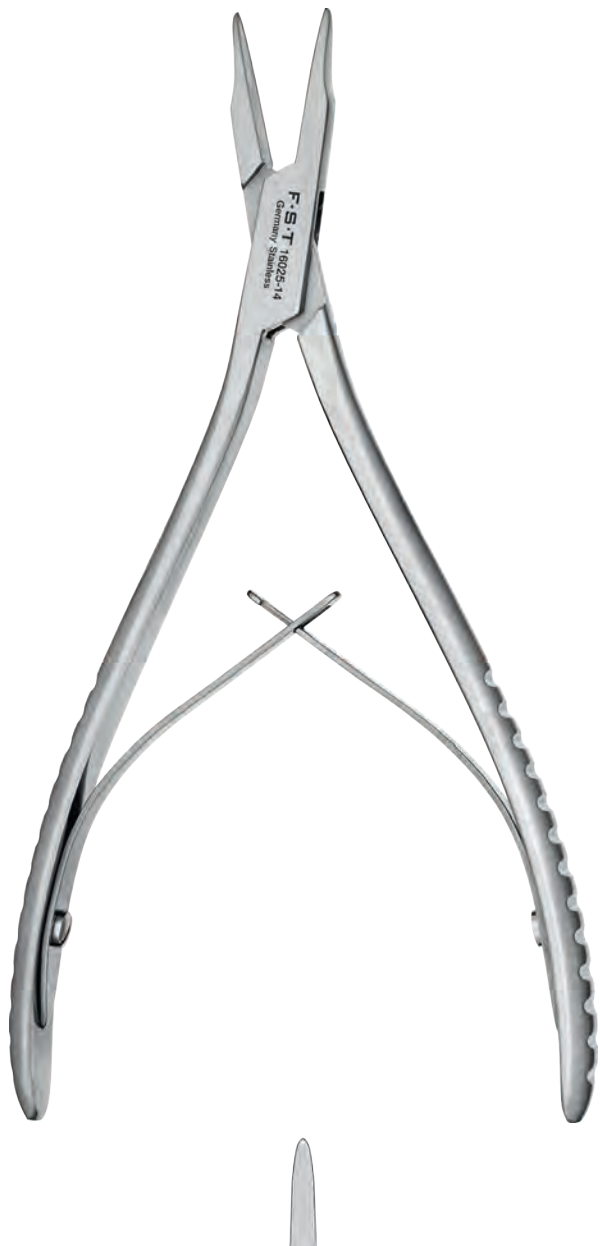

Straight / Flat surface

15.5 cm

No. 16025-14

Bone Shears



60% of actual size

Curved

24 cm
Cutting edge: 6.5 cm

No. 16150-24

Bone Forceps

Strong cross-serrated tips for bone crushing and removal.



Angled

11.5 cm
Tip Ø: 1 mm
Cross serrated

No. 16060-11

Miniature Self-Tapping Bone Screws

Used extensively to anchor dental cement to bone, these self-tapping screws have superior holding strength over ordinary machine screws. Stainless steel with fillister flat head.



4 mm
Shaft diameter: 0.86 mm
Pkg. of 100 screws

No. 19010-10

Pkg. of 10 screws

No. 19010-11

For pre-drilling use our 0.7 mm burrs, see page 181.

4.8 mm
Shaft diameter: 1.19 mm
Pkg. of 100 screws

No. 19010-00

Pkg. of 10 screws

No. 19010-01

For pre-drilling use our 0.9 mm burrs, see page 181.

Bone Wax

A beeswax-based compound for bone hemostasis. Soft, kneadable and ready to use. **Sterile.**



Pkg. of 12 foil packs (2,5 g each)

No. 19009-00

Micro Curette

Curette tips consist of a scoop with sharp edges and are used for scraping or cleaning. They can also be used for separating and transporting, inoculating plates or transferring small amounts of chemicals.



Delicate Bone Scraper

For scraping tissue without cutting into bone.



Austin Chisel



Dissecting Chisel



Serrations on cutting edge



No. 10080-05



No. 10081-10



No. 10082-15



No. 10083-20

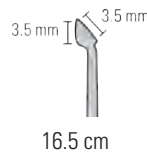

No. 10075-16



No. 10096-16



No. 10097-16



No. 10095-12

Von Graefe Knife

Used for cutting dura.

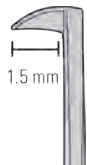

Angled 90°

13 cm
Cutting edge: 1.5 mm

No. 10059-13

Cataract Knife

One of the most popular dissecting knives with a microfine point. The cutting edge is lance shaped to provide the ideal cutting angle.



Straight

12.5 cm
Cutting edge: 4 mm

No. 10055-12



Angled 30°

12.5 cm
Cutting edge: 4 mm

No. 10056-12

Sichel

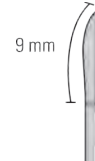

Curved

12 cm
Cutting edge: 9 mm

No. 10073-14

Micro Knife



Straight

13 cm
Cutting edge: 28 mm

No. 10370-13

Micro Knife Side Cut

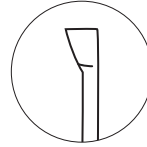

200%



Side cut

15 cm
Cutting edge: 2 mm

No. 10058-15

Circle Knife

Sharp cutting edge around tip.

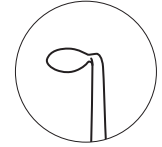

250%



Round

16 cm
Cutting edge: 2 mm

No. 10059-15

Gross Anatomy Knives

Handles are made of fiberglass reinforced yellow nylon with a slip resistant surface that allows little chance of bacterial accumulation. The blades are made of German Molybdenum Stainless Steel.



40% of actual size

Dissection knives

26 cm
Cutting edge: 13 cm

No. 10157-13

28 cm
Cutting edge: 15 cm

No. 10157-15

31 cm
Cutting edge: 18 cm

No. 10157-18



40% of actual size

Brain sectioning knife

44 cm
Cutting edge: 30 cm

No. 10152-30

Obsidian Stone Age Scalpels

For applications where extremely fine cuts are required or for studies where trace metals from ordinary scalpel blades cannot be tolerated. These ultra fine cutting edges have been used in human surgical procedures where objectionable scar tissue results from the use of standard scalpels. The blade is made from obsidian—a type of volcanic glass—which allows a much finer blade than is possible with the conventional steel blade. In some cases this makes the relatively inexpensive obsidian scalpel a suitable substitute for an expensive diamond knife. Patterned after “stone age” knives which first made their appearance about 18,000 years ago, these modern versions utilize hard wood and plastic dowels for handles. Plastic dowels are made of polyoxymethylene.



Cautionary note: Obsidian is a very fragile material. Great care should be taken to not exert any lateral pressure on the blade during cutting. Each blade is hand-fashioned, so sizes, shapes and points will vary. While all the blades will have at least one sharp edge, some will have two.



150%

Wood Dowel
Not autoclavable

Straight

Approximate blade length: 6 mm

No. 10110-01

Straight

Approximate blade length: 12 mm

No. 10110-03



150%

Plastic Dowel
Autoclavable

Straight

Approximate blade length: 6 mm

No. 10110-05



150%

Plastic Dowel
Autoclavable

Angled

Approximate blade length: 6 mm

No. 10110-07

CERAMIC & DIAMOND KNIVES

Ceramic Blades

Advantages:

- Ceramic edge stays sharp 100 times longer than steel edge
- Rust and corrosion free
- Chemical and acid resistant
- Withstands up to 2400°C (4352°F)
- No electrostatic discharge concerns
- No trace metal contamination
- Fully nonmagnetic



Aluminum Alloyed Handle
12.5 cm

No. 10025-50

Ceramic Blades



Angled 45°

33 x 6 x 0.5 mm
Cutting edge: 4.5 mm
Pkg. of 5 blades

No. 10025-44



Angled 45°

33 x 6 x 0.5 mm
Cutting edge: 2.5 mm
Pkg. of 5 blades

No. 10025-43



Angled 23°

33 x 6 x 0.5 mm
Cutting edge: 14 mm
Pkg. of 5 blades

No. 10025-23



Angled 45°

33 x 6 x 0.5 mm
Cutting edge: 8 mm
Pkg. of 5 blades

No. 10025-45

Diamond Knives

This knife has a gem-quality, neutral diamond blade which is honed to the finest cutting edge possible. The blade is made to an ophthalmic surgical standard and is inspected under 400x magnification. The retractable handle aids in care and storage.



Cautionary note: This blade is extremely fragile and vulnerable to lateral pressure.



Cutting angle: 30°

12 cm
Cutting edge: 1 mm
Tip thickness: 0.15 mm

No. 10100-30



Cutting angle: 45°

12 cm
Cutting edge: 1 mm
Tip thickness: 0.15 mm

No. 10100-45



Grip slides up the handle to protect the tip for safe storage and packing.



Blade Holders and Breakers

Breakable Carbon Steel Blades

These special, high carbon content blades are the only blades that will break cleanly.

Not autoclavable.



Blade thickness: 0.1 mm
Pkg. of 10 blades

No. 10050-00

Create Your Own Blade

With these blade holders/breakers and our special carbon steel blades, No. 10050-00, you can produce microblades in sizes that meet your own individual needs.

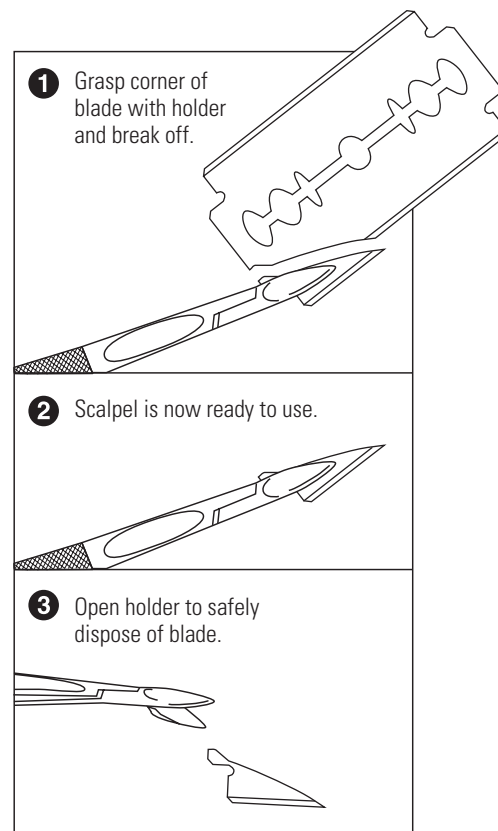

11 cm
Jaw width: 4 mm
Flat surface

No. 10052-11



9 cm
Jaw width: 4 mm
Concave / Convex surface
Handle diameter: 5.5 mm

No. 10053-09

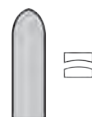

13 cm
Jaw width: 4 mm
Concave / Convex surface
Handle diameter: 8 mm

No. 10053-13

SCALPELS

Carbon Steel Scalpel

Cold forged from carbon steel and sharpened to eliminate tissue distortion and blade drag. 12.5 cm plastic handle with slip-proof grip. **Sterile.**



10316-14
10315-12



22.5° Cutting angle

13.5 cm
Cutting edge: 4.5 mm
Tip thickness: 0.15 mm

No. 10316-14



15° Cutting Angle

13 cm
Cutting edge: 5 mm
Tip thickness: 0.15 mm

No. 10315-12

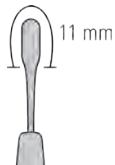

Crescent blade

14 cm
Cutting edge: 11 mm
Tip thickness: 0.2 mm

No. 10317-14



Needle blade

14.5 cm
Cutting edge: 4 mm
Tip thickness: 0.2 mm

No. 10318-14

Interchangeable Carbon Steel Blades



Angled Carbon steel

Cutting edge: 10 mm
Pkg. of 5 blades

No. 10035-15



Curved Carbon steel

Cutting edge: 10 mm
Pkg. of 5 blades

No. 10035-20



Small / Flat Carbon steel

Cutting edge: 1.5 mm
Pkg. of 5 blades

No. 10035-05



Large / flat Carbon steel

Cutting edge: 2.75 mm
Pkg. of 5 blades

No. 10035-10

Handle for Interchangeable Blades
9.5 cm

No. 10035-00

12.5 cm

No. 10035-12



Cane Carbon steel

Cutting edge: 12 mm
Pkg. of 5 blades

No. 10035-25



Arc Carbon steel

Cutting edge: 12 mm
Pkg. of 5 blades

No. 10035-30

Scalpel Handle #4 with Silicone

For heavy, gross anatomy work.
Molded to fit hand.



13.5 cm

No. 10009-13

Standard Scalpel Handle #4 Solid

Especially suitable for large dissections.



13 cm

No. 10004-13

Blades for #4 Scalpel Handle

The alloy used has a high carbon content which provides a longer lasting edge. Blades come individually wrapped. **Non-sterile.**



Box. of 100 blades

No. 10020-00



Box. of 100 blades

No. 10021-00



Box. of 100 blades

No. 10022-00



Box. of 100 blades

No. 10023-00

#3 Standard



12 cm

No. 10003-12

#3 Secure

A safety lock holds the blade securely, and allows simple and safe blade attachment and removal.



12 cm

No. 10003-13

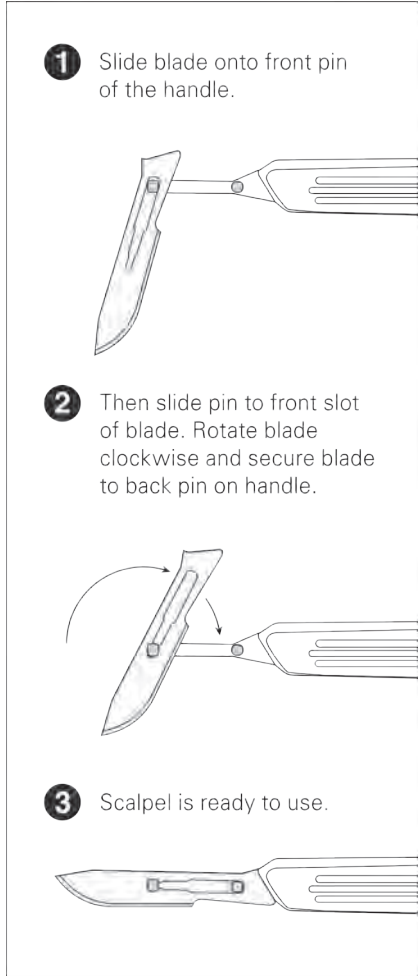

Blades for #3 and #7 Scalpel Handles

The alloy used has a high carbon content which provides a longer lasting edge. Blades come individually wrapped. **Non-sterile.**



Box. of 100 blades

No. 10010-00



Box. of 100 blades

No. 10011-00



Box. of 100 blades

No. 10012-00



Box. of 100 blades

No. 10015-00

Short Scalpel Handle #7

Standard Scalpel Handle #7

Scalpel Blade Remover

For safe removal of scalpel blades, simply insert scalpel with blade into the Scalpel Blade Remover and press the sides together. This will dislodge the blade from handle and hold the blade securely for release.



6.5 cm

No. 10002-00

Scalpel Blade Remover and Disposal Box

This plastic device will remove used scalpel blades safely and retain them for safe disposal. Can be used for blades that fit the #3, #4, #7 and Gross Anatomy handles.

7.5 x 5 x 2.5 cm
Capacity approximately: 80 Blades
Carton of 10 boxes



No. 10002-50

12 cm

No. 10007-12

16.5 cm

No. 10007-16

Your fingers will never come in contact with the blade.

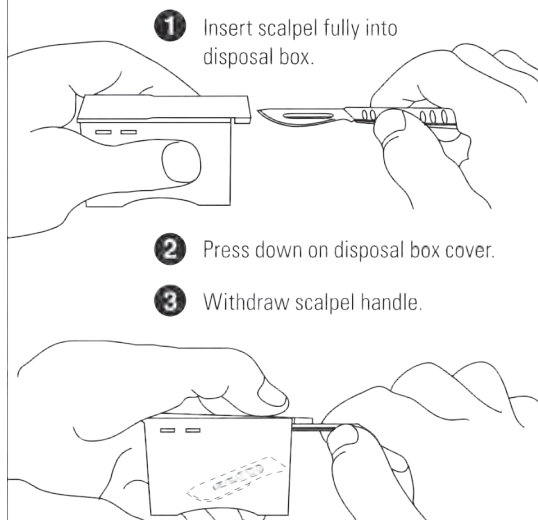

Gross Anatomy Blade and Handle



7.5 cm
Box of 100 blades

No. 10060-00



13 cm

No. 10060-13

Disposable Safety Scalpels

Plastic handle #3 with stainless steel blades. The protective cartridge completely covers the blade for safe, fast and easy disposal. **Single-use and non-sterile.**

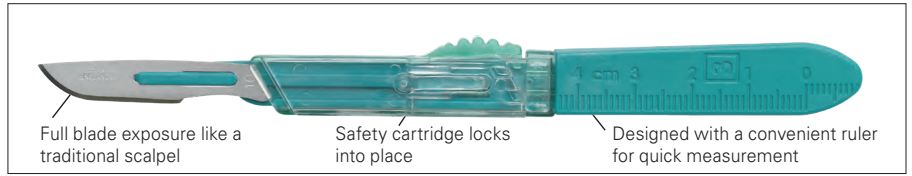

#10 scalpels
Pkg. of 10 blades

No. 10000-10



#11 scalpels
Pkg. of 10 blades

No. 10000-11



#15 scalpels
Pkg. of 10 blades

No. 10000-15



Scalpel shown with safety cartridge closed and locked into place.

Safety Scalpel Blade Cartridges

The Safety Scalpel Handle #3 is compatible with all Safety Scalpel Blades. The handle is reusable and made of Teflon coated stainless steel which provides a non-stick surface. The Blade Cartridges are color-coded with clear windows for easy identification. The protective cartridge completely covers the blade for safe, fast, and easy disposal. **Handle is reusable and autoclavable. Blades are single-use and non-sterile.**

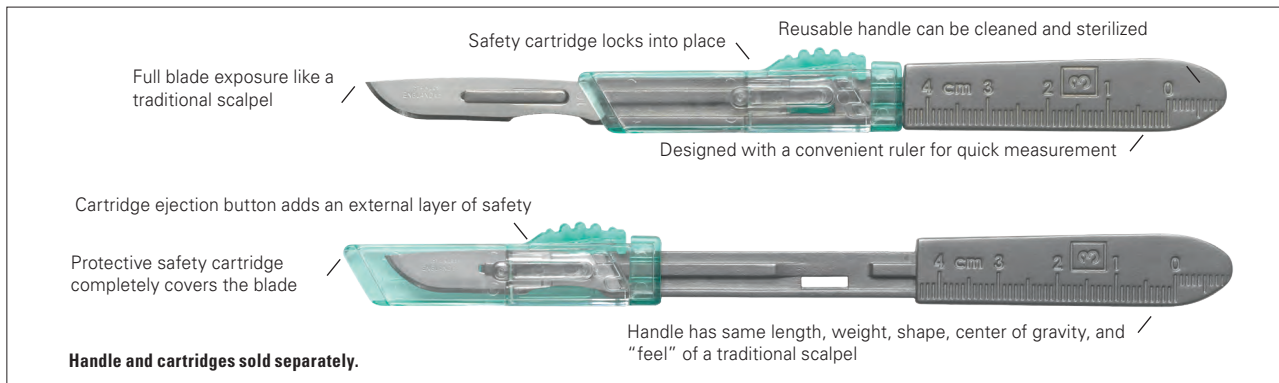

Safety Scalpel Handle #3



12.5 cm
Teflon coated Stainless Steel

No. 10006-12

Safety Scalpel Blade Cartridges

Safety Scalpel Blade Cartridges shown open and attached to handle.
Handle and cartridges sold separately.



#10 blades
Pkg. of 10 blades

No. 10010-10

#11 blades
Pkg. of 10 blades

No. 10011-10

#15 blades
Pkg. of 10 blades

No. 10015-10

FORCEPS, TWEEZERS, HEMOSTATS & VASCULAR INSTRUMENTS

FST by Dumont

79 – 88

Fine

89 – 99

Moria

92 – 93, 95

S&T

94, 96

Standard

100 – 111

Hemostats

112 – 117

Vascular Instruments

118 – 127



Dumont #5SF

The finest tips ever produced by Dumont.

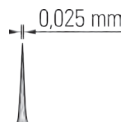

Super fine

11 cm
Inox
0.025 x 0.005 mm

No. 11252-00

**Dumont #5
Fine Tips**

Finished under magnification and polished on the inside, the tips close flat to 3 mm and are less likely to open under excess pressure.

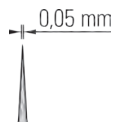

Biology

11 cm
Inox
0.05 x 0.01 mm

No. 11254-20

**Dumont #5
Ceramic Coated**

These forceps are non-reflective. The scratch and corrosion resistant coating guarantees durability.

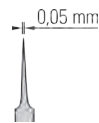

Biology

11 cm
Ceramic coated Inox
0.05 x 0.01 mm

No. 11252-50

Dumont #5CO

These forceps have been honed down to make this the lightest and most precise Dumont forceps available.



Biology

11 cm
Dumostar
0.05 x 0.01 mm

No. 11295-20

FORCEPS/TWEEZERS

**Dumont Medical Micro-Blunted
Atraumatic Tipped Forceps**

The sides of these forceps are distinctively ribbed to provide a better holding surface for maximum control of the instrument. The shanks are arched toward each other to transmit more holding strength to the points. The smooth inside surfaces at the tips will close flat to 5 mm with gentle pressure, increasing the total holding area considerably. The microscopically matched tips are gently blunted to prevent tissue puncture and are recommended as micro needle holders.

FORCEPS/TWEEZERS

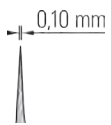

Medical #5

Standard
Straight

11 cm
Inox
0.1 x 0.06 mm

No. 11253-20



Medical #5A

Standard
Off-Center

11.5 cm
Inox
0.13 x 0.08 mm

No. 11253-21



Medical #7S

Standard
Curved

12 cm
Inox
0.17 x 0.1 mm

No. 11273-22



Medical #7

Standard
Curved

11.5 cm
Inox
0.17 x 0.1 mm

No. 11273-20

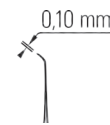

Medical #5/45

Standard
Angled 45°

11 cm
Inox
0.1 x 0.06 mm

No. 11253-25



Medical #5/90

Standard
Angled 90°

11 cm
Inox
0.1 x 0.06 mm

No. 11253-29

Dumont #55

Bevelled, like #5 but with extra light and fine shanks.

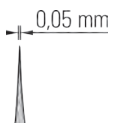

Biology

11 cm
Inox
0.05 x 0.02 mm

No. 11255-20

11 cm
Dumostar
0.05 x 0.02 mm

No. 11295-51

**Dumont #5
Mirror Finish Forceps**

The last 5 mm on the inside of the tips are highly polished to help prevent tissue from sticking. Ideal for embryos, nerves or any other adhesive tissue.

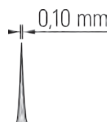

Standard

11 cm
Inox
0.1 x 0.06 mm

No. 11251-23

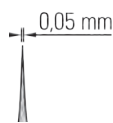

Biology

11 cm
Inox
0.05 x 0.02 mm

No. 11252-23

Dumont #5

These are the most widely used Dumont forceps.
Bevelled, very fine shanks for best visibility.



11251-20
11252-20



11252-40



11251-10

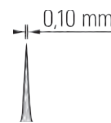

Standard

11 cm
Inox
0.1 x 0.06 mm

No. 11251-20

Dumoxel

No. 11251-30

Dumostar

No. 11295-00

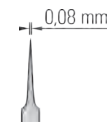

Standard

11 cm
Carbon steel
0.08 x 0.04 mm

No. 11251-10

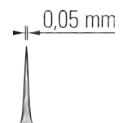

Biology

11 cm
Inox
0.05 x 0.02 mm

No. 11252-20

Dumoxel

No. 11252-30

Dumostar

No. 11295-10

Titanium

No. 11252-40

Dumont WA #5

These specially designed forceps offer improved stability with an ergonomic body that allows the forceps to fit more comfortably in your hand. A domed end with no soldering grooves allows the forceps to be thoroughly and easily cleaned, preventing biofilm residues.

Dumont #5XL

FORCEPS/TWEEZERS



Side View



Standard

12 cm
Inox
0.10 x 0.06 mm

No. 11251-21



Biology

12 cm
Inox
0.05 x 0.02 mm

No. 11252-21



Standard

15 cm
Inox
0.1 x 0.06 mm

No. 11253-10

Dumont #L5

Slide sleeve keeps tips together so specimens may be securely held and retained. Slide may be locked in place so that forceps can be used in regular fashion.

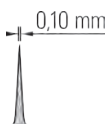

Standard

11 cm
Inox
0.1 x 0.06 mm

No. 11253-27

**Dumont #5
Teflon® Coated**

These antimagnetic forceps are ideal for use in cryogenic environments and for EM samples. Teflon® coating provides a non-stick surface.

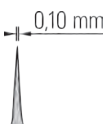

Standard

11 cm
Teflon coated Inox
0.1 x 0.06 mm

No. 11626-11

Dumont #5/45

45° tips for improved visibility and control.



Standard

11 cm
Dumoxel
0.1 x 0.06 mm

No. 11251-35

**Dumont #5/45
Cover Slip Forceps**

Designed to pick up cover slips out of multi-well plates. The tip width is squared for a better grip.



300%



1 mm from tip to bend

11.5 cm
Dumoxel
Upper tip: 0.1 x 0.08 mm
Lower tip: 0.1 x 0.02 mm

No. 11251-33

FORCEPS/TWEEZERS

Dumont #3

Tapered and sturdy shanks.

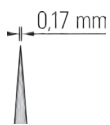

Standard

12 cm
Dumoxel
0.17 x 0.1 mm

No. 11231-30

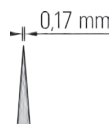

Standard

12 cm
Dumostar
0.17 x 0.1 mm

No. 11293-00

Dumont #3c

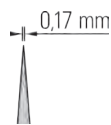

Standard

11 cm
Inox
0.17 x 0.1 mm

No. 11231-20

Dumont #6

Sharply angled tips for access to difficult areas.



Standard

11.5 cm
Inox
0.17 x 0.1 mm

No. 11260-20

**Dumont #7
Fine Tips**

Finished under magnification and polished on the inside, the tips close flat to 3 mm and therefore less likely to open under excess pressure.



0,07 mm
Biology
11.5 cm
Inox
0.07 x 0.03 mm
No. 11274-20

Dumont #7



11272-40



0,17 mm
Standard
11.5 cm
Dumoxel
0.17 x 0.1 mm
No. 11271-30

0,07 mm
Biology
11.5 cm
Dumoxel
0.07 x 0.04 mm
No. 11272-30

Dumostar
No. 11297-10

Titanium
No. 11272-40

**Dumont #7
Ceramic Coated**



0,07 mm
Biology
11.5 cm
Ceramic coated Inox
0.07 x 0.04 mm
No. 11272-50

Dumont #7B



0,17 mm
Standard
11.5 cm
Inox
0.17 x 0.1 mm
No. 11270-20

Dumont #4

Similar to #5, but with broader shanks.

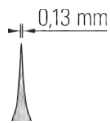

Standard

11 cm
Dumoxel
0.13 x 0.08 mm

No. 11241-30

Dumostar

No. 11294-00

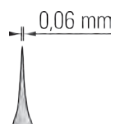

Biology

11 cm
Dumoxel
0.06 x 0.04 mm

No. 11242-40

**Dumont #2
Laminectomy Forceps**

These forceps can be used to break off delicate bone during mouse laminectomies, as well as fine skull bone removal.

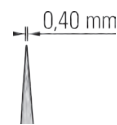

Standard

12 cm
Inox
0.4 x 0.02 mm

No. 11223-20

**Dumont #2AP
Epoxy Coated**

Provides good insulation for up to 220 AC voltage work and highly impervious to chemical solutions. Frozen or super cold sections will not adhere to the gripping surfaces.

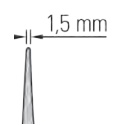

Standard

12 cm
Epoxy coated Inox
1.5 x 0.7 mm

No. 11220-21

Dumont AA



Standard

12.5 cm
Inox
0.4 x 0.2 mm

No. 11210-20

**Dumont AA
Epoxy Coated**

Slip-proof acid and electric shock resistant epoxy coating covering 17.5 mm from the tips.

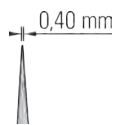

Standard

12.5 cm
Epoxy coated Inox
0.4 x 0.2 mm

No. 11210-10

Dumont SS

The tips are smooth on the inside for a gentle grip. Applying full strength will not separate tips and a strong hold on the smallest specimen is ensured.

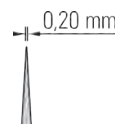

Standard

13.5 cm
Inox
0.2 x 0.12 mm

No. 11203-23

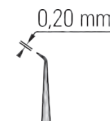

**Standard
Angled 45°**

13.5 cm
Inox
0.2 x 0.12 mm

No. 11203-25

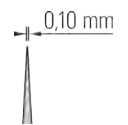

Biology

13.5 cm
Dumoxel
0.1 x 0.06 mm

No. 11200-33

FORCEPS/TWEEZERS

Dumont Mini Forceps

Dumont #2E
Components Forceps

Dumont #5AC

FORCEPS/TWEEZERS

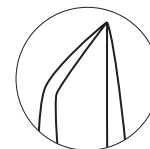

300%

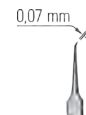
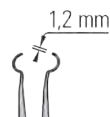
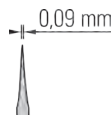
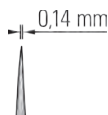
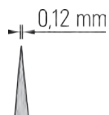

**Mini #3
Standard**

**Mini #4
Standard**

**Mini #5
Standard**

For components

For components

**Type #5 Anti-Capillary
Biology**

7 cm
Inox
0.12 x 0.07 mm

7 cm
Inox
0.14 x 0.06 mm

8.2 cm
Inox
0.09 x 0.05 mm

11.5 cm
Dumoxel
8 x 1.2 mm

11.5 cm
Dumoxel
10 x 1.2 mm

11.5 cm
Inox
0.07 x 0.02 mm

No. 11200-10

No. 11200-12

No. 11200-14

No. 11229-08

No. 11229-10

No. 11258-20

Gold Plated Forceps

Gold-plating gives corrosion resistance to most chemicals, salts and acids. These forceps are perfect for any application where corrosion resistance and toughness are primary requirements.



Straight

11 cm
Gold plated
Stainless Steel
0.1 x 0.06 mm

No. 11915-11



Curved

12 cm
Gold plated
Stainless Steel
0.2 x 0.1 mm

No. 11917-12



Angled 30°

11 cm
Gold plated
Stainless Steel
0.1 x 0.06 mm

No. 11911-11

Diamond Coated Forceps

Diamond coating provides increased corrosion resistance and greater protection from wear and tear, which extends the operational life of the forceps, as well as providing a stronger grip at the tips.

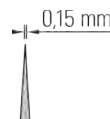

Straight

14 cm
Diamond coated
Stainless Steel
0.15 x 0.1 mm

No. 11990-14

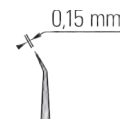

Angled 30°

14 cm
Diamond coated
Stainless Steel
0.15 x 0.1 mm

No. 11991-14



Straight

12 cm
Diamond coated
Stainless Steel
1.65 x 0.05 mm

No. 11992-12

FORCEPS/TWEEZERS

FINE FORCEPS

Mirror Finish Broad Shanks

These forceps have long and narrow shanks with thin, highly polished tips to prevent tissue from sticking. Ideal for embryos, nerves, or other adhesive tissues.

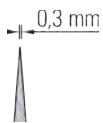

Straight

13 cm
0.3 x 0.15 mm

No. 11923-13

#2A Forceps

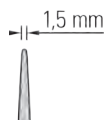

Straight

12 cm
1.5 x 0.13 mm

No. 11992-20

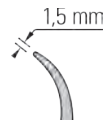

Curved

13 cm
1.5 x 0.1 mm

No. 11972-20

Forceps with Replaceable Tips

Stainless steel body with replaceable plastic tips. Tips are made of polyvinylidene fluoride (PVDF) and are electrostatic discharge (ESD) safe. Body and plastic tips are corrosion and abrasion resistant.

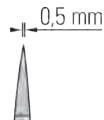

Straight

13 cm
0.5 x 0.5 mm

Stainless Steel body
with plastic tips

No. 11980-13



Pkg. of 2 tips and 3 screws
Replacement plastic tips

Straight / Fine

4 cm
0.6 x 0.6 mm

No. 11988-01



Pkg. of 2 tips and 3 screws
Replacement plastic tips

Straight / Very fine

4 cm
0.5 x 0.5 mm

No. 11988-02



Pkg. of 2 tips and 3 screws
Replacement plastic tips

Curved / Very fine

4 cm
0.5 x 0.5 mm

No. 11988-03

Fine Forceps Broad Shanks

Straight forceps with sturdy coarse tips.

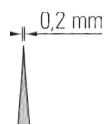

Straight

12 cm
0.2 x 0.12 mm

No. 11445-12

Fine Forceps Mirror Finish

The last 5 mm on the inside of the tips are highly polished to help prevent tissue from sticking. Ideal for embryos, nerves or other adhesive tissue.

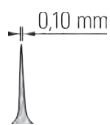

Straight

11 cm
0.1 x 0.06 mm

No. 11412-11

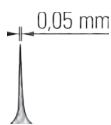

Straight

11 cm
0.05 x 0.02 mm

No. 11413-11

Fine Forceps Self-Closing

Ideal for lifting and holding EM grids. Consistent pressure at tips. Correctly tensioned "cross-over" shanks come to a microscopically matched point

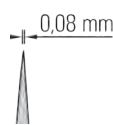

Straight

11.5 cm
0.08 x 0.04 mm

No. 11480-11

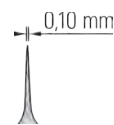

Straight

11 cm
0.1 x 0.06 mm

No. 11485-11



Curved

11.5 cm
0.2 x 0.12 mm

No. 11487-11

FORCEPS/TWEEZERS

Moria Ultra Fine Forceps

These forceps have the most finely executed points available. They are extremely light, superbly balanced and have a gentle spring action. The shanks are specially designed with an arch which ensures maximum force to the tips. The tips close flat for 6 mm from the points to give a large holding area. The tips have been expertly finished under magnification.

Moria Iris Forceps

Balanced with gentle spring action and tips that are perfectly matched.

FORCEPS/TWEEZERS



Moria MC40

Moria MC40/B

Moria 9980

Moria 9987

Moria MC32/B

Moria MC31/B

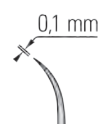
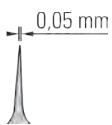

Straight

Curved

Straight

Curved

Straight
Smooth

Curved
Smooth

11 cm
0.05 x 0.01 mm

11 cm
0.05 x 0.01 mm

13 cm
0.1 x 0.06 mm

13 cm
0.1 x 0.06 mm

10 cm
0.5 x 0.3 mm

10 cm
0.5 x 0.4 mm

No. 11370-40

No. 11370-42

No. 11399-80

No. 11399-87

No. 11373-22

No. 11373-12

Moria MC32

Moria MC31

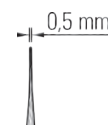

Serrated

Serrated

No. 11370-32

No. 11370-31

Moria Bonn Forceps

Moria Paufigue Forceps



11383-56

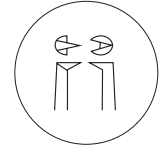

20x magnification



FORCEPS/TWEEZERS

Moria 7835



Straight

Tying platform with
1x2 teeth

7.5 cm
Tip width: 0.3 mm
Tying platform: 4 mm
Stainless Steel

No. 11383-50

Moria T17835



Straight

Tying platform with
1x2 teeth

7.5 cm
Tip width: 0.3 mm
Tying platform: 4 mm
Titanium

No. 11383-56

Moria 3225



Straight

Tying platform with
1x2 teeth

8.5 cm
Tip width: 0.12 mm
Tying platform: 5 mm
Stainless Steel

No. 11390-25

Fine Forceps

SuperGrip Forceps

The tips are processed with MicroCrystals®, a method developed by S&T® to infuse tungsten carbide on stainless steel. The formation of this ultra-fine coating guarantees atraumatic handling of tissue while improving the grip dramatically. The recommended use is where forceps are utilized as needle holders or when slippery tissues might be encountered.

FORCEPS/TWEEZERS



300%
The gripping surface is similar to a match head.

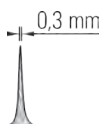

Straight Standard

11 cm
0.3 x 0.25 mm

No. 00108-11



Angled 45° Standard

11 cm
0.3 x 0.25 mm

No. 00109-11

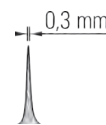

Straight SuperGrip

11 cm
0.3 x 0.25 mm

No. 00632-11

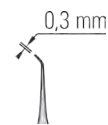

Angled 45° SuperGrip

11 cm
0.3 x 0.25 mm

No. 00649-11

Bonn

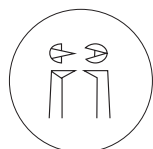

20x magnification

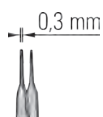

Straight

Smooth with platform

7 cm

Tip width: 0.3 mm

Tying platform: 5 mm

No. 11083-07

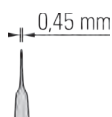

Straight

1x2 Teeth

7 cm

Tip width: 0.3 mm

Teeth width: 0.1 mm

No. 11084-07

Mirror Finish Bonn Forceps

The fine Bonn forceps features a tying platform and is also available with additional 1x2 teeth. It's designed for tissue manipulation and suturing. The wide handle ensures safe handling. The fine and precise tips make it suitable for work under a high magnification.

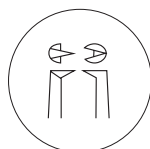

20x magnification



Straight

Tying platform with 1x2 teeth

10.5 cm

Tip width: 0.12 mm

Tying platform: 5 mm

No. 11090-10



Straight

Smooth with platform

10.5 cm

Tip width: 0.3 mm

Tying platform: 5 mm

No. 11093-10

Mirror Finish Suture Tying Forceps with Teeth

A unique tip style fusing a suture tying platform and a 1x2 teeth tip for tissue manipulation.

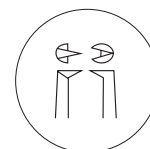

20x magnification

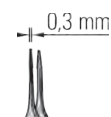

Straight

Tying platform with 1x2 teeth

9 cm

Tip width: 0.3 mm

Tying platform: 6 mm

No. 11090-09

FORCEPS/TWEEZERS

Moria Suture Tying Forceps

Used to suture after surgery is complete. This requires the manipulation of a calibrated nylon thread and the use of a specific instrument: a tying forceps, straight or curved, without teeth.



Moria 9604



Straight

Smooth with platform

9.5 cm

Tip Ø: 0.3 mm

Tying platform: 8 mm

No. 11393-04

Moria 9605

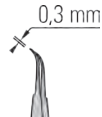

Curved

Smooth with platform

8.5 cm

Tip Ø: 0.3 mm

Tying platform: 7.5 mm

No. 11393-05

McPherson Forceps



Angled 45°

Smooth with platform

9 cm

Tip Ø: 0.4 mm

Tying platform: 6 mm

No. 11063-07

Suture Tying Forceps

The platform tips close flat. This ensures a reliable grip on sutures.

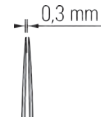
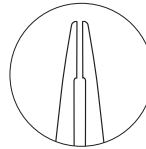

Straight

Smooth with platform

13.5 cm

Tip Ø: 0.3 mm

Tying platform: 6 mm

No. 00272-13

Suture Tying Forceps

The platform tips close flat. This ensures a reliable grip on sutures.



Straight

Smooth with platform

10 cm

Tip Ø: 0.5 mm

Tying platform: 5 mm

No. 18025-10

Round Handled Suture Tying Forceps

Round handles allow easy fingertip adjustments.



Curved

Smooth with platform

10.5 cm

Tip Ø: 0.35 mm

Tying platform: 5.5 mm

No. 18026-10

Vial Forceps

Tips taper for 6 cm allowing easy access to specimens in vials.



Straight

15 cm

Tip Ø: 0.5 mm

No. 11006-15

Vitro Grasping Forceps



Straight

Serrated

14 cm

Tip Ø: 0.7 mm

No. 11900-14

FORCEPS/TWEEZERS

Graefe Forceps



The length of all forceps is 7 cm
The dimensions of all tips are 0.6 x 0.5 mm

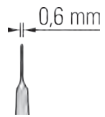

Straight
Serrated

No. 11064-07



Curved
Serrated

No. 11065-07

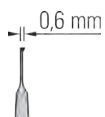

Straight
1x2 Teeth

No. 11066-07



Curved
1x2 Teeth

No. 11067-07

Bishop-Harman

Extra light, fenestrated handles ensure a good grip.

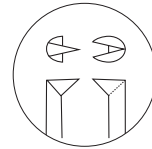

10x magnification

The length of all forceps is 8.5 cm
The dimensions of all tips are 0.5 x 0.5 mm

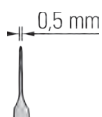

Straight
Serrated

No. 11069-08

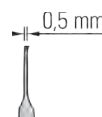

Straight
1x2 Teeth

No. 11070-08

Octagon Forceps

The octagon shaped grip provides a particularly secure finger hold.



The length of all forceps is 9.5 cm
The dimensions of all tips are 0.8 x 0.5 mm



Straight
Serrated

No. 11040-08



Curved
Serrated

No. 11041-08

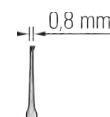

Straight
1x2 Teeth

No. 11042-08



Curved
1x2 Teeth

No. 11043-08

Extra Fine Graefe Forceps



The length of all forceps is 10 cm
The dimensions of all tips are 0.5 x 0.5 mm



Straight
Serrated

No. 11150-10



Slightly curved
Serrated

No. 11151-10



Curved
Serrated

No. 11152-10

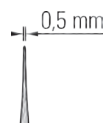

Straight
Smooth

No. 11158-10



Slightly curved
Smooth

No. 11159-10



Curved
Smooth

No. 11160-10



Straight
1x2 Teeth

No. 11153-10



Slightly curved
1x2 Teeth

No. 11154-10



Curved
1x2 Teeth

No. 11155-10

Graefe Forceps



11051-10
11054-10



11650-10 – 11652-10



Straight
Serrated

0.8 x 0.7 mm

No. 11050-10



Slightly curved
Serrated

0.8 x 0.7 mm

No. 11051-10



Curved
Serrated

0.8 x 0.7 mm

No. 11052-10



Angled
Serrated

0.8 x 0.7 mm

No. 11049-10

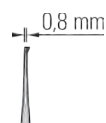

Straight
1x2 Teeth

0.8 x 0.7 mm

No. 11053-10



Slightly curved
1x2 Teeth

0.8 x 0.7 mm

No. 11054-10



Curved
1x2 Teeth

0.8 x 0.7 mm

No. 11055-10



Straight
Serrated

1.2 x 0.9 mm
Titanium

No. 11650-10



Slightly curved
Serrated

1.2 x 0.9 mm
Titanium

No. 11651-10



Curved
Serrated

1.2 x 0.9 mm
Titanium

No. 11652-10



FORCEPS/TWEEZERS

Sliding Lock Forceps



Straight
Smooth

11 cm
1 x 0.75 mm

No. 11062-10

Episcleral Forceps

The tips of these forceps arch toward each other, closing flat. Exceptional gripping power is possible with minimal damage to tissue. A limit pin prevents excessive applied pressure.

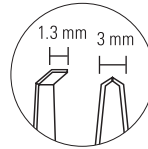

300%



Straight
Arched

10 cm
1.3 x 3 x 0.2 mm

No. 11071-10

Pierson Fixation Forceps

For exceptional gripping power with no damage to sclera, vascular sheath and epineurium.

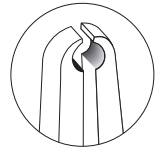

1800%

Tissue retention hole of 0.3 mm behind tips.



Straight
0.3 mm Hole

13 cm
1 x 0.5 mm

No. 18155-13

Plastic Forceps

These forceps are non-magnetic, acid resistant and able to withstand temperatures up to 240°C (464°F). Tips do not spread under pressure. Plastic forceps are made of Acetyl and will be sold in packages of 10 pieces.



Straight
Sharp

11.5 cm
0.4 x 0.25 mm

No. 11700-00



Straight
Blunt

11.5 cm
1.5 x 0.4 mm

No. 11700-03



Curved
Sharp

11.5 cm
0.3 x 0.2 mm

No. 11700-01



Angled 45°
Sharp

11.5 cm
0.3 x 0.2 mm

No. 11700-02



Curved
Blunt

11.5 cm
1.5 x 0.4 mm

No. 11700-04

Cross Action Forceps

These tissue transport forceps have a gentle action.

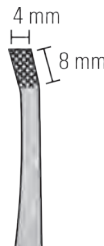

Angled
Cross serrated

10 cm
4 x 8 mm

No. 11075-00

Cover Glass Forceps

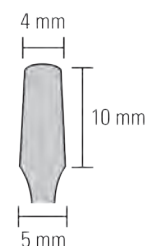

Straight
Smooth

10.5 cm
4 x 10 x 0.6 mm

No. 11074-02



Angled
Smooth

10.5 cm
4 x 10 x 0.6 mm

No. 11073-10

FORCEPS/TWEEZERS

Ring Forceps

For transport of tissue and organs. With limit screw to prevent excessive applied pressure.

Circle Forceps

Cupped forceps for atraumatic gripping of organs and tissues.

Live Insect Handling Forceps

Very delicate.

FORCEPS/TWEEZERS



Straight
Ring

8.5 cm
ID: 1 mm; OD: 1.5 mm
x 0.5 mm

No. 11101-09



Straight
Ring

9 cm
ID: 2.2 mm; OD: 3 mm
x 1.3 mm

No. 11103-09



Straight
Ring

9 cm
ID: 4.8 mm; OD: 6 mm
x 1.5 mm

No. 11106-09



Straight
Circle

11.5 cm
7 x 0.5 mm

No. 11072-11



Straight
Narrow

10 cm
0.9 x 0.15 mm

No. 26029-10



Straight
Wide

10 cm
2.3 x 0.3 mm

No. 26030-10

Micro-Adson

Our most delicate version of the popular Adson forceps.



Straight
Serrated

12 cm
0.8 x 0.9 mm

No. 11018-12

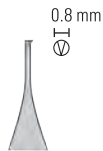

Straight
1x2 Teeth

12 cm
0.8 x 0.9 mm

No. 11019-12

Micro-Adson with Fenestrated Handle

Our delicate Micro-Adson forceps, with five windows to aid in stability and easy finger adjustments.



Straight
Serrated

12 cm
0.8 x 1 mm

No. 11020-12

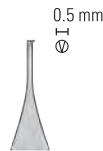

Straight
1x2 Teeth

12 cm
0.5 x 0.6 mm

No. 11032-12

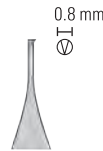

Straight

Tying platform with
1x2 teeth

12 cm
0.8 x 2 mm
Tying platform: 6 mm

No. 11022-12

Adson

Wide, strong grip with narrow tips.



11006-12
11027-12



11506-12



Straight
Serrated

12 cm
1.5 x 1 mm

No. 11006-12

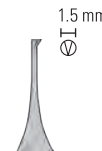

Straight
1x2 Teeth

12 cm
1.5 x 0.8 mm

No. 11027-12



Straight

Cross Serrated
Tungsten Carbide

12 cm
1.5 x 1.3 mm

No. 11506-12

Adson DeBakey



Atraumatic DeBakey Serrations

This tooth pattern, as shown, consists of one row of atraumatic teeth meshed with two opposite rows of atraumatic teeth.

These two forceps are ideal for gentle, atraumatic gripping of vessels, tissue and other delicate structures.

Straight
DeBakey serrations

12.5 cm
1.75 x 1.5 mm

No. 11617-12

Straight
DeBakey serrations

15 cm
1.75 x 1.5 mm

No. 11616-15

Adson-Graefe



Straight
Fine teeth

12.5 cm
4.5 x 1.25 mm

No. 11030-12

Adson-Brown



Straight
Shark teeth

12 cm
2 x 1.4 mm

No. 11627-12

Standard Pattern

Broad pattern with strong spring action.

Narrow Pattern

Lighter spring action than standard pattern for grasping more delicate tissue.



11602-14



Straight Serrated

Length (cm)	Tip width (mm)	Item
12	2.5	No. 11000-12
13	2.8	No. 11000-13
14.5	3.25	No. 11000-14
16	3.3	No. 11000-16
18	3.7	No. 11000-18
20	3.75	No. 11000-20
25	3.9	No. 11000-25
30	4	No. 11000-30



Curved Serrated

Length (cm)	Tip width (mm)	Item
12	2.5	No. 11001-12
13	2.8	No. 11001-13
14.5	3.25	No. 11001-14
16	3.3	No. 11001-16
18	3.7	No. 11001-18
20	3.75	No. 11001-20



Straight Serrated

Length (cm)	Tip width (mm)	Item
12	2	No. 11002-12
13	2.15	No. 11002-13
14.5	2.25	No. 11002-14
14.5	2.25	No. 11602-14
16	2.35	No. 11002-16
18	2.4	No. 11002-18
20	2.75	No. 11002-20
25	3.2	No. 11002-25



Curved Serrated

Length (cm)	Tip width (mm)	Item
12	2	No. 11003-12
13	2.15	No. 11003-13
14.5	2.25	No. 11003-14
16	2.35	No. 11003-16
18	2.4	No. 11003-18
20	2.75	No. 11003-20

FORCEPS/TWEEZERS

Semken

The Semken tweezers are characterized by their slim shape and fine tips. Their anatomical (toothing) or surgical (1x2 teeth) tips make them ideal for grasping tissue. The serrated grip surface ensures a secure hold during use.



11608-15



FORCEPS/TWEEZERS



Straight
Serrated

13 cm
Tip width: 1.3 mm

No. 11008-13



Curved
Serrated

13 cm
Tip width: 1.3 mm

No. 11009-13



Straight
1x2 Teeth

12.5 mm
Tip width: 1.3 mm

No. 11024-12

15 cm
Tip width: 1.5 mm

No. 11008-15

15 cm
Tip width: 1.5 mm
Titanium

No. 11608-15

15 cm
Tip width: 1.5 mm

No. 11009-15

DeBakey Round Handle Forceps

Ideal for gentle, atraumatic gripping of vessels, tissue and other delicate structures. Two rows of atraumatic teeth interfit with one opposite row of atraumatic teeth. The round handles allow easy fingertip adjustments.



Straight
DeBakey serrations

15 cm
Tip width: 1.2 mm

No. 11076-15

Multipurpose Forceps

Balanced instruments are designed to put the center of gravity between the thumb and index finger. This is accomplished by adding a slight counter weight to the proximal end of the instruments. The design enhances tactile feel, aiding in better control and precision.

The tips of these multipurpose forceps are configured to enable their use as dilators at the front, as well as needle holders and tying forceps further in the back. The platform at the tips close parallel ensuring a reliable grip.



Straight

Suture tying platform

14.5 cm

Tip Ø: 0.1 mm

No. 18601-15



Straight

Suture tying platform

15 cm

Tip Ø: 0.3 mm

No. 18602-15



Angled

Smooth

14.5 cm

Tip Ø: 0.2 mm

No. 18603-14

Tissue Forceps



Straight
1x2 Teeth / Narrow

10 cm

No. 11023-10

12 cm

No. 11023-12

14.5 cm

No. 11023-14

15.5 cm

No. 11023-15



Straight
1x2 Teeth / Standard

12 cm

No. 11021-12

14.5 cm

No. 11021-14

15.5 cm

No. 11021-15



Straight
2x3 Teeth / Standard

14.5 cm

No. 11022-14

15.5 cm

No. 11022-15

Tissue Forceps

Used with rongeur No. 16021-14 in laminectomy to securely hold spinal column.



Curved
1x2 Teeth / Narrow

14 cm

No. 11029-14

Gillies

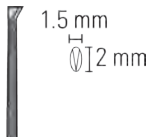

Straight
1x2 Teeth & cross serrated

15 cm
1.5 x 2 mm

No. 11028-15

Russian

Special cupped pattern for superior grip.

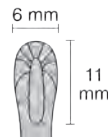

Straight
Cupped teeth

15 cm
6 x 11 mm

No. 11026-15

Organ Holding Forceps

With limit screw to prevent excessive applied pressure.



Straight
Serrated

14.5 cm
8 x 11 mm

No. 11031-15

London Forceps



Angled
Serrated

16 cm
1 x 0.9 mm

No. 11080-02

Titanium Forceps



Straight
Serrated

16 cm
0.3 x 0.5 mm

No. 11602-16

Gerald Forceps



Straight
Serrated

18 cm
1.4 x 1 mm

No. 11014-18



Curved
Serrated

18 cm
1.4 x 1 mm

No. 11015-18

Taylor Forceps

Serrated and smooth versions available.



Straight
Serrated

17 cm
1.5 x 1 mm

No. 11010-17



Straight
Smooth

17 cm
1.5 x 1 mm

No. 11016-17



Curved
Serrated

17 cm
1.5 x 1 mm

No. 11011-17



Curved
Smooth

17 cm
1.5 x 1 mm

No. 11017-17

Potts-Smith Forceps



Straight
Serrated

18 cm
1.25 x 1 mm

No. 11012-18

21 cm
1.8 x 1.5 mm

No. 11012-21

25 cm
2 x 1.6 mm

No. 11012-25



Curved
Serrated

18 cm
1.25 x 1 mm

No. 11013-18

21 cm
1.8 x 1.5 mm

No. 11013-21



Straight
1x2 Teeth

18 cm
1.25 x 1 mm

No. 11024-18



Curved
1x2 Teeth

18 cm
1.25 x 1 mm

No. 11025-18

Mouse Handling Forceps

Long handles make picking up small rodents easy and help prevent bites.



21 cm
Forceps with serrated
silicone tips
Gripping surface:
15 x 20 mm

No. 11036-20



Replacement silicone tips
Pkg. of 2 tips

No. 11036-90

FORCEPS/TWEEZERS

Ultra Fine Hemostat

Fine Hemostat



**Straight
Smooth**
12 cm
Tip width: 0.6 mm
No. 13020-12

**Curved
Smooth**
12 cm
Tip width: 0.6 mm
No. 13021-12

**Straight
Smooth**
12 cm
Tip width: 1 mm
No. 13006-12

**Curved
Smooth**
12 cm
Tip width: 1 mm
No. 13007-12

Micro-Mosquito



Straight Serrated

12 cm
Tip width: 1 mm

No. 13010-12



Curved Serrated

12 cm
Tip width: 1 mm

No. 13011-12



Angled 90° Serrated

12 cm
Tip width: 1 mm

No. 13012-12

Halsted-Mosquito



13008-12



13108-12
13109-12



Straight Serrated

12.5 cm
Tip width: 1.3 mm

No. 13008-12

Left handed

No. 13108-12



Curved Serrated

12.5 cm
Tip width: 1.3 mm

No. 13009-12

Left handed

No. 13109-12

HEMOSTATS

Crile

Kelly



Straight Serrated

14 cm
Tip width: 1.5 mm

No. 13004-14



Curved Serrated

14 cm
Tip width: 1.5 mm

No. 13005-14



Straight Serrated

14 cm
Tip width: 1.5 mm

No. 13018-14



Curved Serrated

14 cm
Tip width: 1.5 mm

No. 13019-14

Baby-Mixer

Providence-Hospital



**Curved
Serrated**

14 cm
Tip width: 1.3 mm

No. 13013-14



**Straight
Serrated**

14 cm
Tip width: 1.5 mm

No. 13014-14



**Curved
Serrated**

14 cm
Tip width: 1.5 mm

No. 13015-14

HEMOSTATS

Hartmann



13003-10



10 cm
Tip width: 1 mm

No. 13002-10



10 cm
Tip width: 1 mm

No. 13003-10

Backhaus Towel Clamp



9 cm

No. 11095-09



13 cm

No. 11095-13

Allis Clamp

Tissue and organ holding forceps.



4 mm

**Straight
5x6 Teeth**15 cm
Tip width: 4 mm**No. 11091-15**

3 mm

**Straight
4x5 Teeth**12 cm
Tip width: 3 mm**No. 11092-12****Lorna Towel Clamp****Curved
Serrated**10 cm
Tip width: 7 mm**No. 11096-10****Curved
Serrated**13 cm
Tip width: 7 mm**No. 11096-13**

MICRO CLAMPS

Clamp Size and Clamp Pressure

Clamp pressure is determined by the closing force of the clamp (in grams), divided by the area of the vessel wall that is compressed between the jaws (in square millimeters). Thus, the smaller the vessel, the higher the pressure exerted.

Despite the wide range of closing forces, the pressure exerted by each clamp, big or small, remains consistent throughout the series. Each size of clamp exerts a pressure of 5g/mm² when used on the largest vessel in its range, and 15g/mm² when used on the smallest vessel. Even at the higher range, S&T's micro clamps have the gentlest working pressure of any small vessel clamp available.

Clamp (ea)	L x W (mm)	Vessel Diameter Range (mm)
00396-01 & 18040-11	3.5 x 1.0	0.4 - 1.0
00398-02 & 18040-22	5.5 x 1.5	0.6 - 1.5
00400-03 & 18040-33	7.5 x 1.75	1.0 - 2.25
00325-00	10 x 2.15	2.0 - 5.0

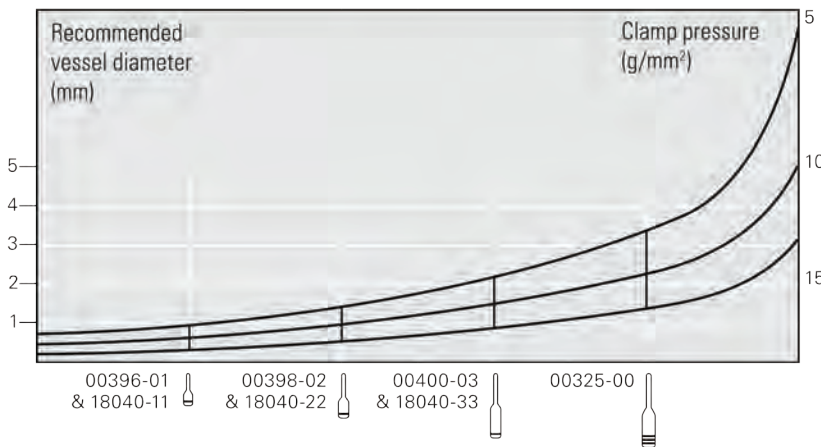
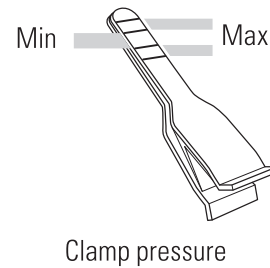

Micro Clamps

S&T®



S&T B-1

No. 00396-01



S&T B-2

No. 00398-02



S&T B-3

No. 00400-03



S&T HD-S

No. 00325-00

Double Micro Clamps

For vascular approximation at anastomosis. These clamps are mounted on a 10 mm sliding bar and can easily be moved by applying gentle force. The distance between the jaws of the clamps is adjustable from 3 to 16 mm.



No. 18040-11



No. 18040-22



No. 18040-33

Micro Clamp Applying Forceps



14 cm

Only compatible with
S&T Micro Clamps
Lock: Yes

No. 00071-14

Lock: No

No. 00072-14



Micro Clamp Applying Forceps



14.5 cm

Compatible with S&T Micro Clamps
and Double Micro Clamps.

Lock: No

No. 18040-14

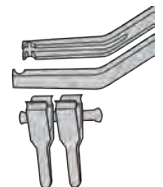
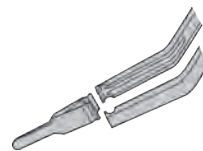

CLAMPS

Micro Clip Applicator with Lock



14 cm

For use with FST 18055 and 18555 series micro serrefines.

Lock: Yes

No. 18056-14

Forceps Style Clip Applicator

This applicator features special U-shaped side supports for improved seating of the clips.



14 cm

For use with FST 18055 and 18555 series micro serrefines.

Lock: No

No. 18057-14

Biemer Clip Applicator (Forceps Style)

Application forceps for Biemer clamps made of surgical stainless steel.



14 cm

For use with FST 18058 (Biemer Clip) series

Lock: No

No. 18059-14

Stainless Steel Micro Serrefines

Used to obtain a clear surgical field for extended arterial cross-clamping.



Micro Serrefines should never be compressed with fingers; use only the appropriate applicator No. 18056-14 or No. 18057-14.

Delicate atraumatic serration



Jaw dimensions (mm)	Total length (mm)	Jaw pressure (g)	Item
10 x 2	19	60	No. 18055-01
8 x 2	16	85	No. 18055-02
6 x 1	15	100	No. 18055-03
4 x 0.75	13	125	No. 18055-04

Jaw dimensions (mm)	Total length (mm)	Jaw pressure (g)	Item
6 x 1	17	85	No. 18055-05
4 x 0.75	16	85	No. 18055-06

Titanium Micro Serrefines

Lightweight with strong clamping pressure.

Delicate atraumatic serration



Jaw dimensions (mm)	Total length (mm)	Jaw pressure (g)	Item
10 x 2	19	60	No. 18555-01
8 x 2	16	85	No. 18555-02
6 x 1	15	100	No. 18555-03
4 x 0.75	13	125	No. 18555-04



Moria Vessel Clamp

Straight
33 mm
Serrated: Yes
Light pressure
Jaw dimensions: 13 x 1.6 mm



Moria 201/A
No. 18320-11

Moria Bulldog Type Clamps

53 mm
Serrated: No
Strong pressure
Jaw dimensions: 16 x 2.5 mm



Straight
Moria MC43
No. 18374-43



Curved
Moria MC44
No. 18374-44

Bulldog Artery Spring Clamp

Can be used with a minimum of distortion for MRI investigations.



Straight
30 mm
Serrated: Yes
Light pressure



No. 18144-30

Dietrich Bulldog Clamps

Serrated: Yes

Closing pressure: 50 g



Straight
52.5 mm
No. 18038-45



Angled
50 mm
No. 18039-45

Bulldog Type Serrefines

Serrated: Yes

Straight
28 mm
Medium pressure



No. 18050-28

Curved
28 mm
Medium pressure



No. 18051-28

Straight
35 mm
Strong pressure



No. 18050-35

Straight
50 mm
Strong pressure



Curved
35 mm
Strong pressure



No. 18051-35

Curved
50 mm
Strong pressure

No. 18051-50

Schwartz Micro Serrefines

Serrated: No
Strong pressure
26 mm



Straight
No. 18052-01



Light bend
No. 18052-02



Sharp bend
No. 18052-03



Biemer Clip

Serrated: Yes
Straight

Closing pressure: 0.29 - 0.39 N / 30 - 40 g
15 mm

Clamping Length: 6 mm

No. 18058-15



18 mm
Clamping Length: 9 mm

No. 18058-18



Mini Serrefines

28 mm
Medium pressure
Serrated: Yes
Jaw dimensions: 6 x 2 mm

Straight
No. 18054-28



Curved
No. 18053-28



VASCULAR INSTRUMENTS

Horizon™ Metal Ligation System

The Horizon™ System provides surgeons with a strong, secure clip coupled with an efficient, convenient easy-load cartridge system. The preformed chevron shape of the Horizon™ Clip engulfs tissue with precise tip-to-tip closure. Heart-shaped wire is designed to give each clip a firm grip on vessels, while the triangulated cross-section of the clip leg maximizes surface-to-surface contact between clip and jaw, practically eliminating clip fallout.



Horizon™
Ligation Clips
1.98 x 2.87 mm
Pkg. of 6 Clips
Sterile: No

No. 18070-10



Horizon™
Ligation Applicator

Curved
20 cm

No. 18070-00

Horizon™
Clip Remover

Straight
16.5 cm

No. 18073-00

Silver Neuro Clips

These single-use, silver neuro clips are meant for permanent vessel occlusion.

Pkg. of 100 clips

No. 18040-00

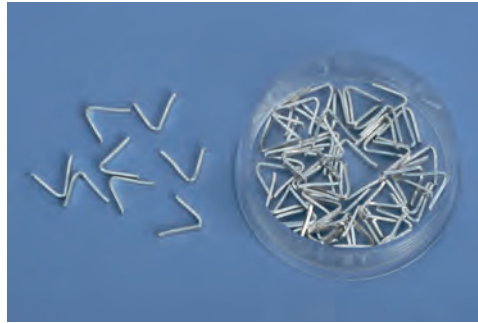

Vascular Occluders

Applications

- Fast, dependable zero-flow baseline determination in blood flow studies.
- Partial to full occlusion of vessels for circulation research studies.
- Prolonged implantations, such as chronic blood flow studies.
- Constriction of soft organs in acute or chronic applications.

Operation instruction

1. Apply the occluder cuff around the exposed blood vessel. Secure it in place with suture material through the eyelets.
2. Occlude the vessel to the desired degree by inflating the diaphragm with air or liquid injected into the actuating tube using a syringe and blunt needle. Clamp the tubing to maintain occlusion of the vessel over time.
3. To deflate, simply withdraw the air or liquid.

Benefits

- Occlusion is accomplished without traction on vessels or surrounding tissues.
- The actuating tube may be exteriorized from the occlusion site for remote actuation.
- Performance during implantations is reliable and consistent.
- Easily maintained: can be autoclaved or cold sterilized.
- Made from soft, flexible 100% silicone rubber.
- Fully operational with instant response using air, liquids, or inert gases.

Selection

The lumen diameter when deflated is usually the determining factor in the selection of the proper device. Select the occluder size that provides a slightly loose fit around the subject vessel. The cuff width and thickness will vary, depending on models and sizes.

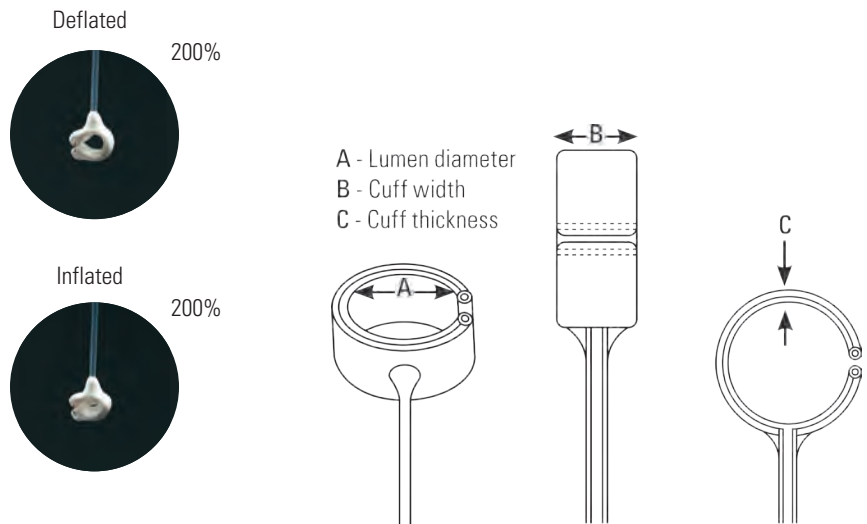

The actuating tube length is 90 cm and measures 0.76 mm ID x 1.6 mm OD. Detailed instructions are included.

- A: Lumen diameter
- B: Cuff width
- C: Cuff thickness

VO-1.5 N

A: 1,5 mm; B: <3,5 mm; C: 1,5 mm

No. 18080-01

VO-2

A: 2 mm; B: 5 mm; C: 1.5 mm

No. 18080-02

VO-3

A: 3 mm; B: 5 mm; C: 1.5 mm

No. 18080-03

Vessel Dilators

Highly modified forceps with elongated, parallel tips which are highly polished. Designed for controlled intraluminal vessel dilation.

S&T®

S&T®



Angled 10°

11 cm
Tip Ø: 0.1 mm

No. 00126-11

Tip Ø: 0.2 mm

No. 00125-11



Angled 45°

13.5 cm
Tip Ø: 0.2 mm

No. 00276-13

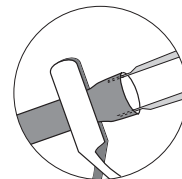

Angled 10°

12 cm
Tip Ø: 0.1 mm

No. 18131-12

Tip Ø: 0.2 mm

No. 18132-12

V-Hook

Aids in feeding fine suture around blood vessels, works very similar to ligation aids.

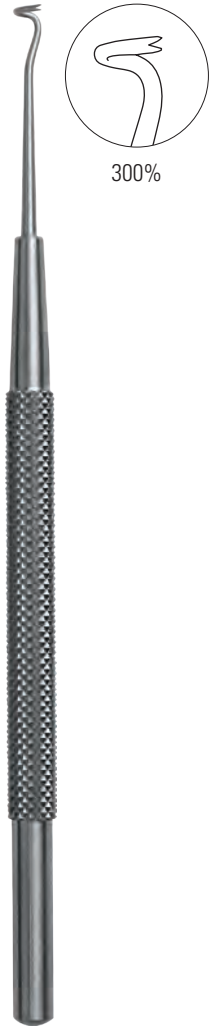

300%



11 cm
Tip Dimensions: 0,4 x 0,2 mm

No. 18052-12

Ligation Aids

A handy instrument for leading a fine suture under and around a blood vessel for tying-off purposes. Also useful for ligating peripheral nerves. Grooves toward hole help threading.



300%



10.5 cm
Hole Ø: 0.4 mm

No. 18062-12



200%

200%



13.5 cm
Hole Ø: 1 mm

No. 18062-13



13.5 cm
Hole Ø: 1 mm

No. 18063-13

VASCULAR INSTRUMENTS

Micro Cannulation System

This micro cannula is most helpful for quick and easy insertion in arteries and veins. It can be used as an “indwelling” catheter during long term experiments. With care, thorough rinsing and sterilization, it can be reused several times. Detailed instructions are included.



Features

- Biocompatible Teflon® tubing.
- Cannula size 0.33 mm OD – 0.16 mm ID
- A pointed stainless steel stylus (trocar), to aid in vascular penetration and allow a maximum range of cannula manipulation during insertion.
- Contoured tip for easy insertion, fitted with shoulder for “tie-in” to prevent accidental removal.
- Female luer connection for linkage to infusion lines.

1 Approach

Cannulation Forceps (Item No. 18403-11) and Spinal Cord Hook (Item No. 10162-12) aid in the insertion process.

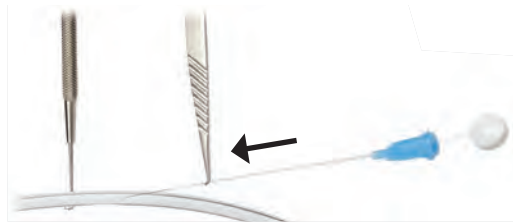

2 Insertion

Remove trocar and advance cannula.



3 Secure

Use shoulder hub and suture to “tie in” cannula to prevent accidental removal.



Instruments sold separately.

8 cm

Cannula size: 0.33 mm OD - 0.16 mm ID

No. 18000-10

Vessel Cannulation Forceps

These vessel cannulation forceps are useful whenever a fine plastic tube has to be introduced into a small blood vessel of almost equal size. The hollowed jaws hold the tubing securely without deforming it. The tip of the tubing is directed exactly into the vessel opening without damage to the vessel from unwanted movement.

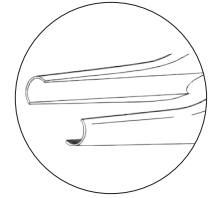

11 cm
For tubing of 0.35 mm OD
No. 00608-11

11 cm
For tubing of 0.5-1 mm OD
No. 00574-11



13 cm
For tubing of 0.35 mm OD
No. 11280-11

11 cm
For tubing of 0.5 mm OD
No. 11281-11

11 cm
For tubing of 1 mm OD
No. 11282-11



11.5 cm
For tubing of 0.35 mm OD
No. 18403-11

11.5 cm
For tubing of 0.6 mm OD
No. 18406-11

13.5 cm
For tubing of 0.6 mm OD
No. 18406-13

VASCULAR INSTRUMENTS

PROBES, NEEDLE HOLDERS, WOUND CLOSURE, RETRACTORS & CLAMPS

Probes & Hooks 129 – 134

Spatulae 132, 135 – 138

Spoons 139

Pins & Holders 140 – 141

Wound Closure 142 – 153

Retractors 154 – 161



Double Pronged Pick

For peritoneum, pleura, endocardium, organ capsules and skin. Grasps lifts skin, tissue and dura etc.

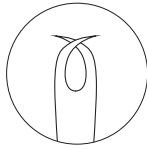

700%

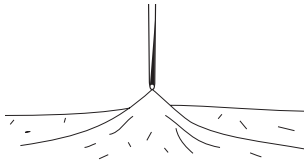

The tip consists of two very sharp, nearly horizontally opposed points. By applying gentle downward pressure and twisting slightly in a clockwise fashion, the points will embed themselves horizontally into fine membranes or skin etc., so that it may be lifted upward. This instrument also has been used successfully when separating fine tissue from an underlying area that is not to be cut.



11 cm
Tip Ø: 1 mm

No. 18067-11

Spinal Cord Hook

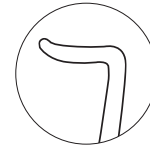

300%

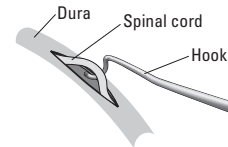

Shaped like a ligation aid and sized to isolate the spinal cord from the dura of adult mice and neonatal rats. The cord can then be cut with minimal damage to the dura.



11 cm
Tip Ø: 3 mm

No. 10162-12

Bonn Micro Probes

Micro Points

Actual size



Angled 45°

13.5 cm
Tip Ø: 0.025 mm

No. 10032-13



Actual size

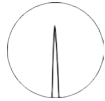

Straight

13.5 cm
Tip Ø: 0.025 mm

No. 10030-13

300%



Angled 90° Short

15.5 cm
Tip Ø: 0.05 mm

No. 10063-15



Actual size



Wide Hook

13.5 cm
Tip Ø: 0.038 mm

No. 10033-13

Actual size



Narrow Hook

13.5 cm
Tip Ø: 0.025 mm

No. 10031-13

300%



Angled 45°

15.5 cm
Tip Ø: 0.038 mm

No. 10066-15

300%



Angled 90° Long

15.5 cm
Tip Ø: 0.02 mm

No. 10065-15

Probes and Explorers

Mico Hooks



10140-01



Actual size



Angled 80° Short

15.5 cm
Tip Ø: 0.12 mm

No. 10140-04

Actual size



Straight

15.5 cm
Tip Ø: 0.25 mm

No. 10140-01

Actual size



Angled 80° Long

15.5 cm
Tip Ø: 0.15 mm

No. 10140-03

Actual size



Angled 80°

15.5 cm
Tip Ø: 0.15 mm

No. 10140-02

175%



Micro hook

13 cm
Tip Ø: 0.05 mm

No. 10064-14



175%



Blunt hook

12 cm
Tip Ø: 0.3 mm

No. 10062-12

175%



Sharp hook

12 cm
Tip Ø: 0.075 mm

No. 10061-12

Titanium Micro Point, Y-Hook, and Spatula

These instruments are lightweight, color coded for easy identification, have an ergonomic design and a non-reflective surface.



650%

Micro Point



Angled 45°

12.5 cm
Tip Ø: 0.4 mm

No. 10165-11



700%

Y-Hook



Angled 45°

12.5 cm
Tip width: 0.5 mm

No. 10166-11



700%

Micro Spatula



Angled 30°

12.5 cm
Tip: 0.25 x 0.6 mm

No. 10167-11

Vessel Dilating Probe



200%

Angled

12.5 cm
Tip Ø: 0.6 mm

No. 10160-13

Gross Anatomy Probe



Angled 45°

15 cm
Tip Ø: 1.2 mm

No. 10088-15

Grooved Director

The Grooved Director is a specialized multipurpose device which is used by surgeons in different areas to probe cavities and wounds for example.



13 cm
with Tongue Tie

No. 10290-13

Combination Spoon and
Spatula

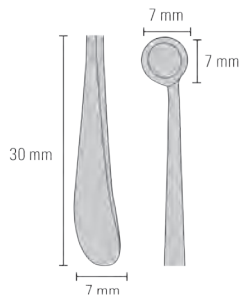

F · S · T
10090-17

17.5 cm
Top: Ø 7mm / Bottom 30 x 7mm

No. 10090-17

Combination Probe and
Spatula



14 cm
13 x 7 x 0.6 mm
Tip Ø: 0.1 mm

No. 10090-13

Micro Spatula

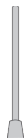

Straight

11 cm
17.5 x 1 x 0.25 mm

No. 10089-11

Mirror Finish Micro Spatula

Mirror finished to provide a non-stick spatula.



Curved

12 cm
15 x 0.8 x 0.25 mm

No. 10087-12

Double-Ended Micro Spatula

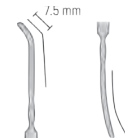

Curved/Angled

13 cm
25 x 2 x 0.3 mm

No. 10091-12

Iris Spatula



SPATULAE



Curved

12 cm
20 x 1.8 x 0.3 mm

No. 10092-12



Slightly curved

13 cm
23 x 1.7 x 0.3 mm

No. 10093-13



Straight

13 cm
33 x 3 x 0.4 mm

No. 10094-13

Micro Spatula Kit

Kit with 4 pieces

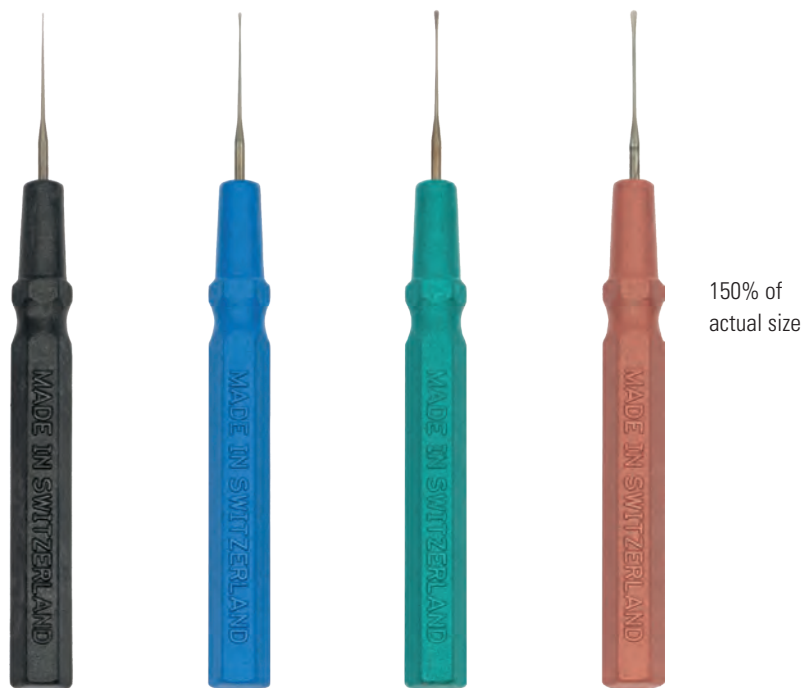

SPATULAE

Black



Blue



Green



Red



Straight

6 cm

Tip Ø: Black: 0.2 mm, Blue: 0.3 mm, Green: 0.5 mm, Red: 0.7 mm

No. 10098-06

Mini Hippocampal Dissecting Tool

The instrument ends are malleable to allow you to adjust their shape to the correct angle for optimal positioning.



14.5 cm
20 x 6 mm & 13 x 3 mm
Tip thickness: 0.5 mm

No. 10099-12

Hippocampal Dissecting Tool

The instrument ends are malleable to allow you to adjust their shape to the correct angle for optimal positioning.



16 cm
27 x 14 mm & 27 x 6 mm
Tip thickness: 0.5 mm

No. 10099-15

Spoon



Moria 1121B

12.5 cm
Tip Ø: 8 mm
Depth: 2 mm

No. 10321-08

Mini Perforated Spoon

Most commonly used to take embryos out of solution and handling very small organs



Moria MC 17C

10 cm
Tip Ø: 8 mm
Depth: 1 mm
Hole Ø: 0.8 mm

No. 10370-19

Perforated Spoon

Most commonly used to take embryos out of solution and handling very small organs.

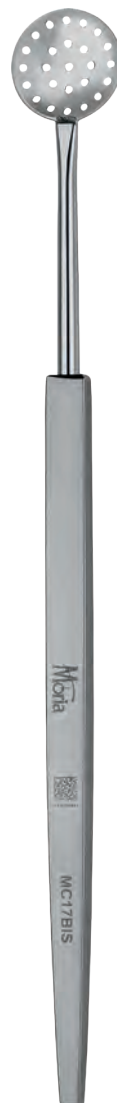

Moria MC 17 BIS

14.5 cm
Tip Ø: 15 mm
Depth: 3 mm
Hole Ø: 0.9 mm

No. 10370-18



Moria MC 17

14.5 cm
Tip Ø: 20 mm
Depth: 5 mm
Hole Ø: 0.9 mm

No. 10370-17

Mirror Finish Cutting Spoon

Non stick cutting spoon.



13 cm
Tip Ø: 4.5 mm
Depth: 0.15 mm

No. 10360-13

SPOONS

Pin Holder

Light weight



17 cm

Aluminum handle with nickel-plated chuck
Jaw opening: 0 to 1 mm

No. 26018-17

Pin Holder



12 cm

Nickel-plated
Jaw opening: 0 to 1 mm

No. 26016-12

Insert Pins

All insert pins fit any of our pin holders.
Pins are antimagnetic and acid resistant.

5 cm
Stainless Steel



Lancet

No. 26007-01



Straight

No. 26007-02



Curved

No. 26007-03



Lancet half

No. 26007-04



Spatula

No. 26007-05

Black Anodized Minutien Pins

These high quality pins are black for best visibility under high magnification and bright light.



Tip Ø: 0.0175 mm
Rod Ø: 0.15 mm
1.2 cm
Box of 500 pins

No. 26002-15



Stainless Steel Minutien Pins

The thinnest and finest pins available.



Tip Ø: 0.0125 mm
Rod Ø: 0.1 mm
1.2 cm
Box of 500 pins

No. 26002-10

Tip Ø: 0.0175 mm
Rod Ø: 0.15 mm
1.2 cm
Box of 500 pins

No. 26003-15

Tip Ø: 0.02 mm
Rod Ø: 0.2 mm
1.2 cm
Box of 500 pins

No. 26002-20

Black Anodized Insect Pins

Nylon heads

Tip Ø: 0.03 mm

Pkg. of 100 pins

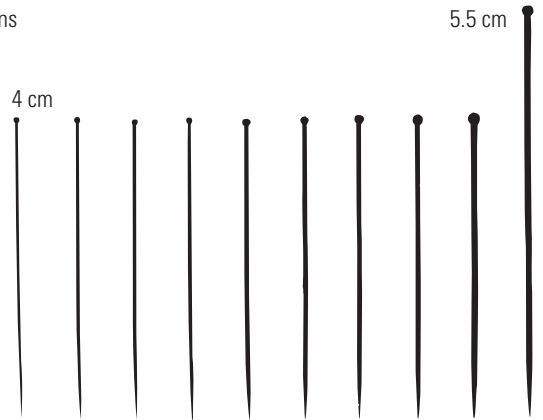

Size	000	00	0	1	2	3	4	5	6	7
Rod Ø (mm)	0.25	0.3	0.35	0.4	0.45	0.5	0.55	0.6	0.65	0.7
No. 26000	-25	-30	-35	-40	-45	-50	-55	-60	-65	-70

Stainless Steel Insect Pins

Nylon heads

Tip Ø: 0.03 mm

Pkg. of 100 pins

Size	000	00	0	1	2	3	4	5	6	7
Rod Ø (mm)	0.25	0.3	0.35	0.4	0.45	0.5	0.55	0.6	0.65	0.7
No. 26001	-25	-30	-35	-40	-45	-50	-55	-60	-65	-70

Etched Tungsten Micro Needles

These tungsten micro needles are drawn to a 1 micron tip and three different rod diameters are offered. Each provides lateral stability as well as minimal spring action during manipulation. The micro needles can be used with our pin holders shown on page 140.



Tip Ø: 1 µm (0.001 mm)
Box of 10 needles

Rod Ø (mm)	Item
0.125	No. 10130-05
0.25	No. 10130-10
0.5	No. 10130-20

Castroviejo

Micro pattern, with slightly blunted tips.



Straight

9 cm
Lock: Yes

No. 12060-01

Lock: No

No. 12060-02



Curved

9 cm
Lock: Yes

No. 12061-01

Lock: No

No. 12061-02

Kalt Needle Holder

The Kalt needle holder is characterized by its extraordinary design and good handling. The closure system closes softly and securely and can be easily opened again with your thumb.



Straight

Serrated: Yes
13.5 cm
Lock: Yes

No. 12080-14

Curved

Serrated: Yes
13.5 cm
Lock: Yes

No. 12081-14



Never use a micro needle holder with needles that are too thick, as this can easily damage the fine jaws. Use only micro needles of less than 0.2 mm diameter (see page 148).

Round Handled Needle Holder

Round handles allow easy fingertip adjustments.



Straight

12.5 cm
Lock: Yes

No. 12075-12



Curved

12.5 cm
Lock: No

No. 12074-12

Lock: No

No. 12076-12

Round Handled Needle Holder with Suture Cutter

Round handles allow easy fingertip adjustments.

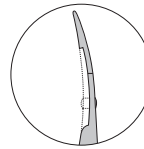

actual size



Curved

14 cm
Cutting edge: 3.5 mm
Lock: No

No. 12075-14



CAUTIONARY NOTE
Never use a micro needle holder with needles that are too thick, as this can easily damage the fine jaws. Use only micro needles of less than 0.2 mm diameter (see page 148).

Castroviejo with Tungsten Carbide Jaws



14 cm
Tungsten Carbide jaws
Lock: Yes

No. 12565-14

WOUND CLOSURE

Halsey



13 cm
Smooth
Lock: Yes

No. 12001-13



13 cm
Tungsten Carbide jaws
Lock: Yes

No. 12501-13

Halsey with Tungsten Carbide Jaws



12.5 cm
Tungsten Carbide jaws
Lock: Yes

No. 12500-12

WOUND CLOSURE

Mathieu

Extra slim and narrow profile, with squeeze-lock.
Facilitates excellent wrist motion for suturing.



14 cm
Lock: Yes

No. 12010-14



14 cm
Tungsten Carbide jaws
Lock: Yes

No. 12510-14

Olsen-Hegar with Suture Cutter



12102-12

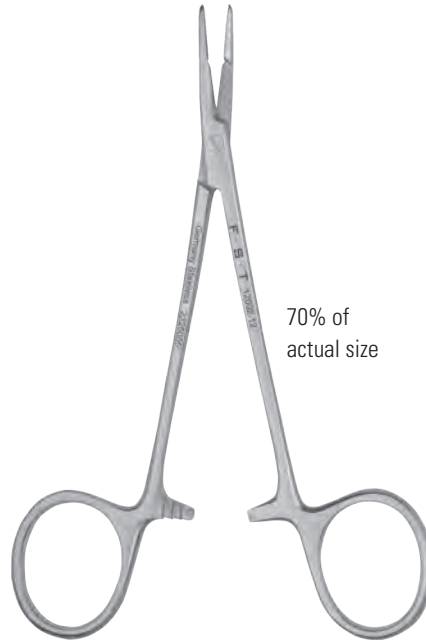

70% of actual size



12 cm
Cutting edge: 10 mm
Lock: Yes

No. 12002-12

No. 12102-12



14 cm
Cutting edge: 15 mm
Lock: Yes

No. 12002-14

Olsen-Hegar with Suture Cutter and Tungsten Carbide Jaws



12512-12



70% of actual size



12 cm
Tungsten Carbide jaws
Cutting edge: 10 mm
Lock: Yes

No. 12502-12

No. 12512-12



14 cm
Tungsten Carbide jaws
Cutting edge: 15 mm
Lock: Yes

No. 12502-14

WOUND CLOSURE

NEEDLE HOLDERS

Crile-Wood



12504-15

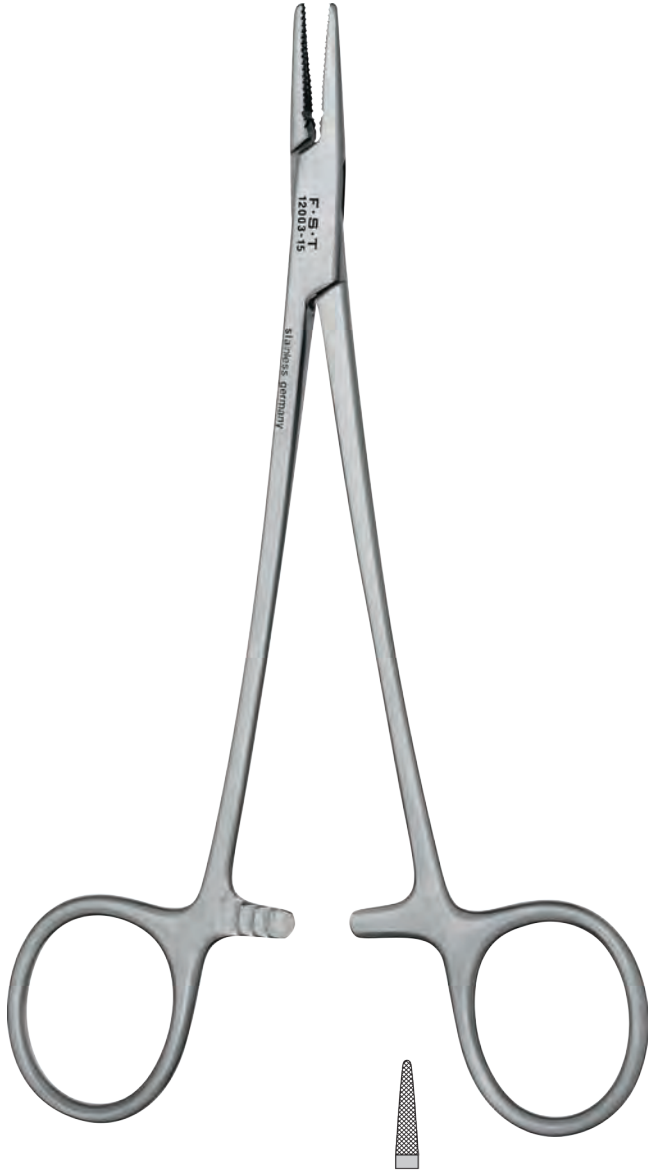

15 cm
Lock: Yes

No. 12003-15



15 cm
Tungsten Carbide jaws
Lock: Yes

No. 12503-15

No. 12504-15

Mayo-Hegar



16 cm
Lock: Yes

No. 12004-16



18 cm
Lock: Yes

No. 12004-18

WOUND CLOSURE

Slim Elongated Needle Holder with Tungsten Carbide Jaws



15 cm
Tungsten Carbide jaws
Lock: Yes

No. 12005-15

Ryder Mini-Select Needle Holder

This needle holder has been uniquely fashioned with tungsten carbide dust tips, giving the clamping platform an extra secure grip.



15 cm
Tungsten Carbide jaws
Lock: Yes

No. 12505-15

WOUND CLOSURE

Microsurgical Needles with Suture Thread Attached

The combination of proprietary needle design technology and state-of-the-art manufacturing techniques has enabled FST to provide a microsurgical needle that is unmatched in the industry. FST microsurgical needles provide frictionless tissue penetration. They are inspected under the microscope at critical stages during the manufacturing process, and a multi-point final inspection of each suture and needle combination ensures a high quality product.

The suture-to-needle attachment is tested to higher standards than the USP specifications.

Features:

- Needle and thread combination comprising of nonabsorbable black nylon polyamide monofilament thread and stainless steel 3/8 circle needle. Nylon is suitable for closing ophthalmic, neurological and microvascular wounds.
- 3/8 circle precision taper point. Stainless steel needle honed under microscope by hand. Superfine round tip with flattened body to improve stability in needle holder. Easy penetration. Precise stitch placement.
- Grinding geometry and suture needle attachment are directed toward frictionless tissue penetration.
- Each needle suture combination is individually packed and sealed in a peel-open blister pack.

Sterile

Pkg. of 12 disposable units

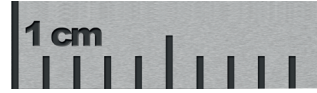
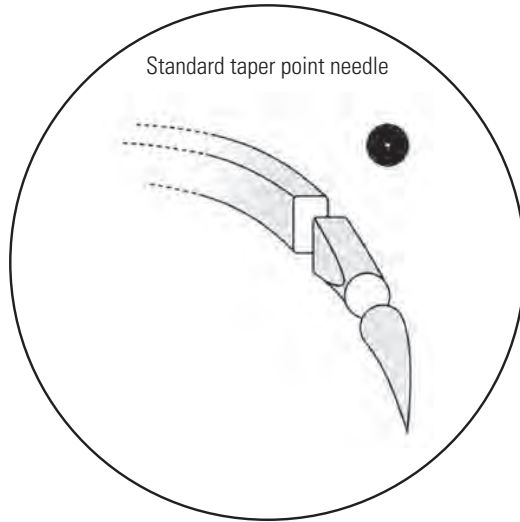

400% of actual size

No. 12052-11



No. 12052-10



No. 12052-09

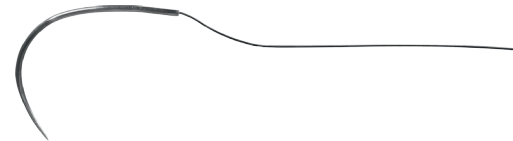

No. 12052-08



Suture size	Suture length (cm)	Needle Ø (micron)	Needle Ø (mm)	Needle chord length (mm)	Circle	Arch (mm)	Item
11/0	10	50	0.05	3.8	3/8	3.8	No. 12052-11
10/0	10	70	0.07	3.8	3/8	3.8	No. 12052-10
9/0	15	100	0.1	5	3/8	5.1	No. 12052-09
8/0	15	140	0.14	5	3/8	6.4	No. 12052-08

Suture Needles

- Polished stainless steel
 - 3/8 curved
 - Round with standard eye
 - Suitable for sutures up to 0.32 mm diameter
- Ø: 0.35 mm

Sterile: No

Pkg. of 12 needles

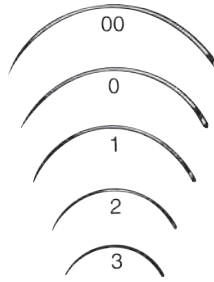

Size	Item
00	No. 12050-20
0	No. 12050-10
1	No. 12050-01
2	No. 12050-02
3	No. 12050-03

Silk Suture

Silk suture has a smooth flow through tissue while maintaining knot security.

Braided Silk

Sterile: No

Can be ETO sterilized



Size	Suture Ø (mm)	Spool length (m)	Item
7/0	0.05	91	No. 18020-70
6/0	0.08	23	No. 18020-60
5/0	0.12	23	No. 18020-50
4/0	0.17	23	No. 18020-40
3/0	0.22	23	No. 18020-30
2/0	0.32	23	No. 18020-20
0	0.37	23	No. 18020-00
1	0.45	23	No. 18020-01
2	0.55	23	No. 18020-02
3	0.65	23	No. 18020-03

WOUND CLOSURE

For Suture Tying Forceps, see pages 79, 80 and 81.

Nylon Monofilament Suture

Nylon is known for its uniform diameter flexibility and outstanding consistent knot security.

Nylon monofilament

Non sterile

Can be ETO sterilized



Size	Suture Ø (mm)	Spool length (m)	Item
8/0	0.04	91	No. 18030-80
7/0	0.05	91	No. 18030-70
6/0	0.07	91	No. 18030-60
5/0	0.1	91	No. 18030-50
4/0	0.15	91	No. 18030-40
3/0	0.2	91	No. 18030-30

Suturing Principles and Techniques in Laboratory Animal Surgery

This manual introduces the reader into the basic principles, materials and surgical instruments required for suturing and wound closure used on laboratory animals. It provides descriptions and pictures portraying proper tissue handling and aseptic technique, correct hand placement and use of surgical instruments, proper needle placement on needle holders, and provides an in-depth explanation of various suture patterns and associated principles for proper knot tying during wound closure.

The included DVD provides descriptive narrative and step-by-step video demonstrations for each of the suturing techniques.

For your convenience all instruments which are used for the demonstrations are listed with their FST item numbers

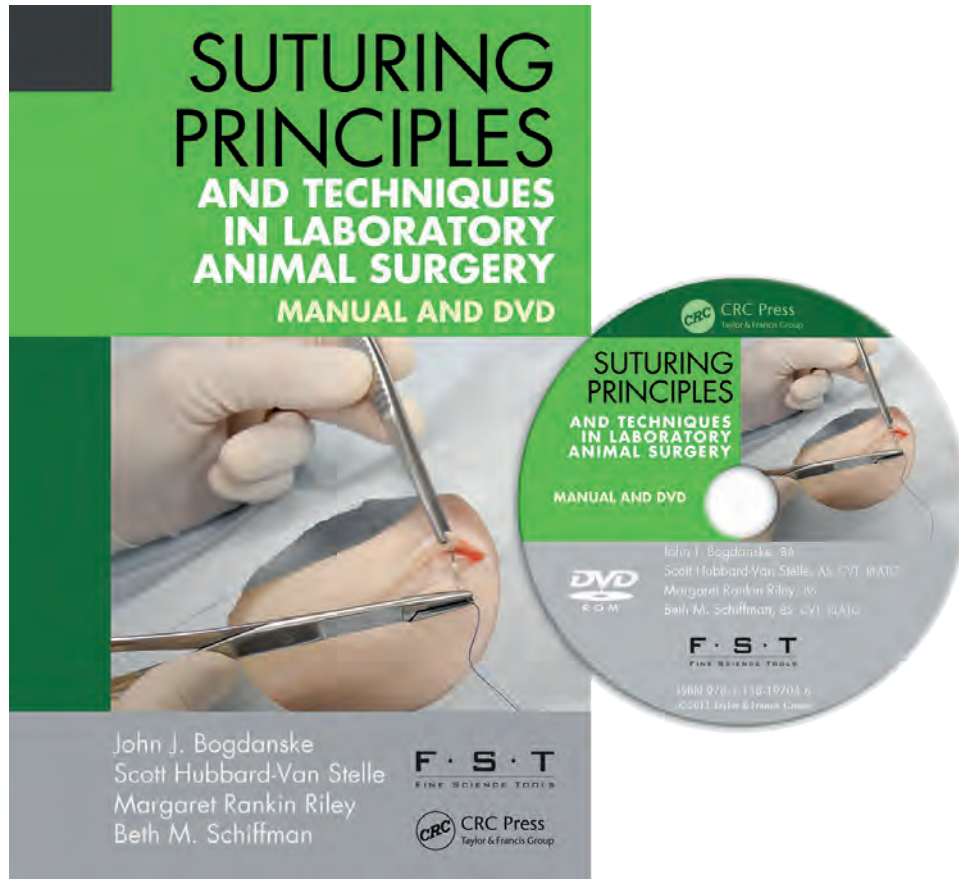

No. 23005-10

Michel Suture Clips

- Anti-magnetic
- Acid-resistant stainless steel
- Pkg. of 1.000 clips

Size (mm)	Item
7.5 x 1.75	No. 12040-01
11 x 2	No. 12040-02
12 x 2.5	No. 12040-03



Applying Forceps



12.5 cm
For clip sizes 12040-02 and 12040-03

No. 12018-12

Applying and Removing Instruments



Angled

13 cm
For clip size 12040-01

No. 12029-12



Curved

13 cm
For clip sizes 12040-02 and 12040-03

No. 12028-12

WOUND CLOSURE

Reloadable Skin Stapler with Rotating Head

The 360° degree swivel nose and unique design offers maximum visibility at the delivery point. The stainless steel staples are non-sterile and feature a patented staple design which make for quick and easy removal. The disposable staple cartridge includes a printed staple counter.

The handle is reusable and autoclavable. Staples are non-sterile. Components sold separately or as a kit.

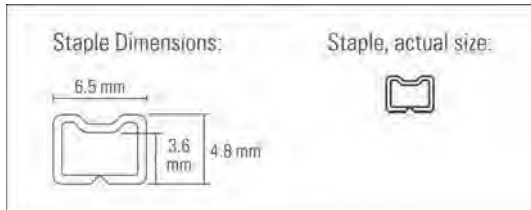
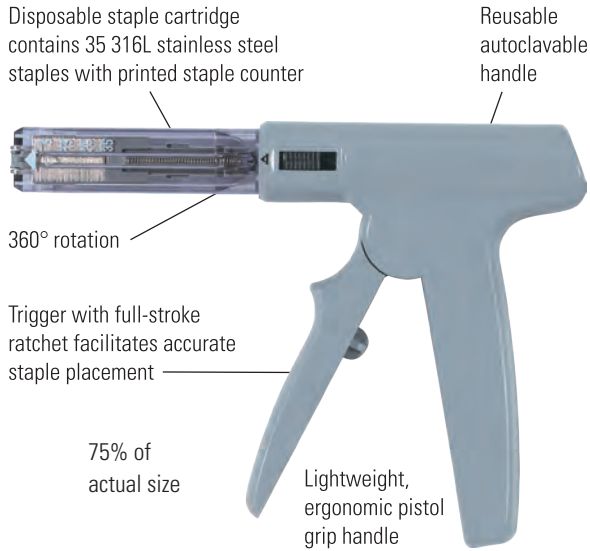

Surgical staple kit

- 1 Handle
- 1 Remover
- 12 Disposable staple cartridges

No. 12030-20

Single disposable cartridge
35 staples per cartridge

No. 12030-22

12 disposable cartridges
35 staples per cartridge

No. 12030-23

Handle

No. 12030-01

Surgical Staple Remover

Compatible with Reloadable Skin Stapler with Rotating Head and Manipler® Skin Stapler.



10 cm

No. 12030-04

Manipler® Skin Stapler

Quality, slim, lightweight design with consistent actuation and staple count indicator.

Disposable, sterile and not autoclavable.

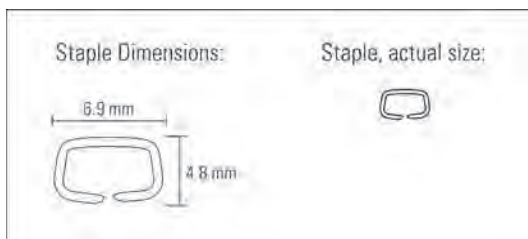

No. 12035-00

AutoClip® System

The AutoClip® System is a safe, secure method of wound closure. Faster and easier than suture, this system is perfect when staples may be too thin to provide adequate closure. **Non-sterile. Components sold separately or as a kit.** We recommend using wet steam sterilization at 120 – 125°C for at least 30 minutes in an autoclave to sterilize the device.

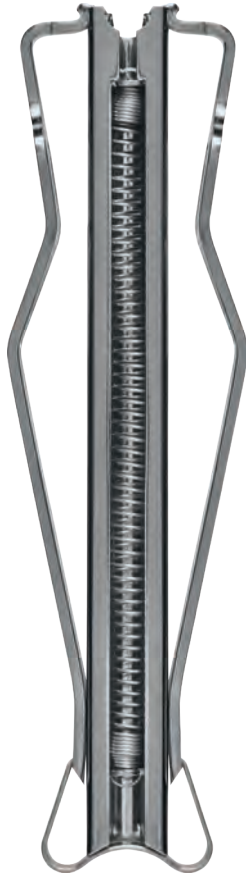

Applier



Clips



Remover

WOUND CLOSURE

AutoClip® Kit

- 1 Applier
- 9 mm clips (100)
- 1 Remover
- Storage case

AutoClip® applier
11.5 cm

AutoClip® clips
9 mm
Pkg. of 100 clips

AutoClip® clips
9 mm
Pkg. of 1000 clips

AutoClip® remover
12.5 cm

No. 12020-00

No. 12020-09

No. 12022-09

No. 12022-19

No. 12023-00

RETRACTORS

Guthrie

Extra delicate pattern.



2.5 mm



13 cm
2 Blunt

No. 17021-13

Fine Retractor



6 mm



13.5 cm
2 Blunt

No. 17023-13

Blair



6 mm



13.5 cm
4 Blunt

No. 17022-13

Fomon



80% of actual size

13 mm



17 cm
2 with 2 mm Ball each tip

No. 17020-17

RETRACTORS

Slide Retractor with Blades

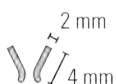

2 cm
Max. spread: 1 cm

No. 17004-03

Mini-Goldstein

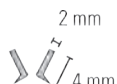

2 cm
Max. spread: 0.5 cm
3 x 3 Sharp teeth

No. 17002-02

Mini-Colibri

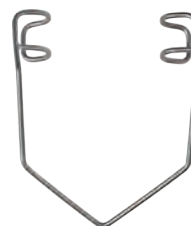

2 cm
Max. spread: 1 cm

No. 17000-01

Slide Retractor with Teeth

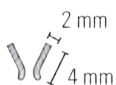

2 cm
Max. spread: 1 cm
2 x 2 Blunt teeth

No. 17005-03

Goldstein



3 cm
Max. spread: 1.8 cm
3 x 3 Sharp teeth

No. 17003-03

Colibri



17000-03

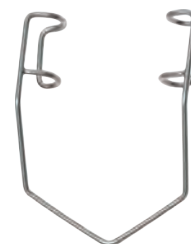

3 cm
Max. spread: 1.5 cm

No. 17000-03

4 cm
Max. spread: 1.5 cm

No. 17000-04



3 cm
Max. spread: 1.2 cm

No. 17000-02

Speculum

Moria

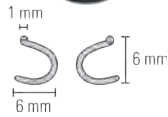

Moria 7699

4.5 cm
Max. spread: 3.5 cm
Curved

No. 17370-53

Fine Adjustable Wire Retractor



5 cm
Max. spread: 3.5 cm
Curved

No. 17004-05

Colibri

Moria

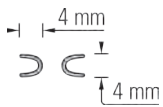

Moria 6346D

3.4 cm
Max. spread: 1.5 cm

No. 17300-02

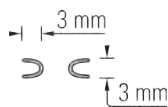

Moria 6346C

3.3 cm
Max. spread: 1.5 cm

No. 17300-03

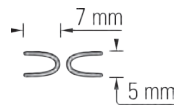

Moria 6346B

3.5 cm
Max. spread: 2 cm

No. 17300-04

Agricola

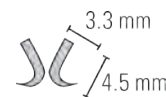

4 cm
Max. spread: 3.5 cm
3 x 3 Sharp teeth

No. 17005-04

Alm Retractor with Wire Teeth



7 cm
 Max. spread: 4 cm
 Slightly curved down

No. 17010-07

Alm Retractor with Blunt Teeth



5.5 mm



7 cm
 Max. spread: 4 cm
 Slightly curved
 4 x 4 Blunt

No. 17008-07

16 mm



7 cm
 Max. spread: 4 cm
 Slightly curved
 4 x 4 Blunt

No. 17009-07

Alm Retractor with Blades



4.5 mm



7.5 cm
 Max. spread: 4.5 cm
 Slightly bent

No. 17009-08

Spring-Loaded Retractor

Curved atraumatic blades

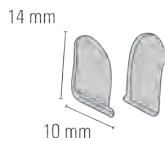

5.5 cm
Max. spread: 3 cm
14 x 10 mm

No. 17006-05



8 cm
Max. spread: 4 cm
22 x 16 mm

No. 17007-08

Bowman

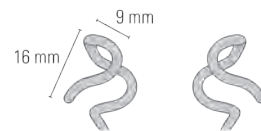

8 cm
Max. spread: 2.5 cm

No. 17001-07

Heiss

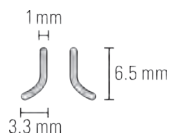

10 cm
Max. spread: 2.3 cm
4 x 4 Blunt teeth

No. 17011-10

Gelpi

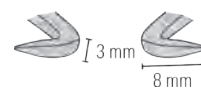

10 cm
Angled down
Max. spread: 3 cm
1 x 1 Sharp teeth

No. 17017-10

RETRACTORS

Weitlaner-Locktite

Wullstein

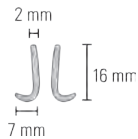

Straight
2 x 3 Blunt teeth
11 cm
Max. spread: 4 cm

No. 17012-11



Straight
3 x 4 Blunt teeth
13 cm
Max. spread: 4 cm

No. 17012-13

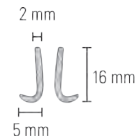

Angled down
3 x 3 Blunt teeth
11 cm
Max. spread: 3 cm

No. 17018-11

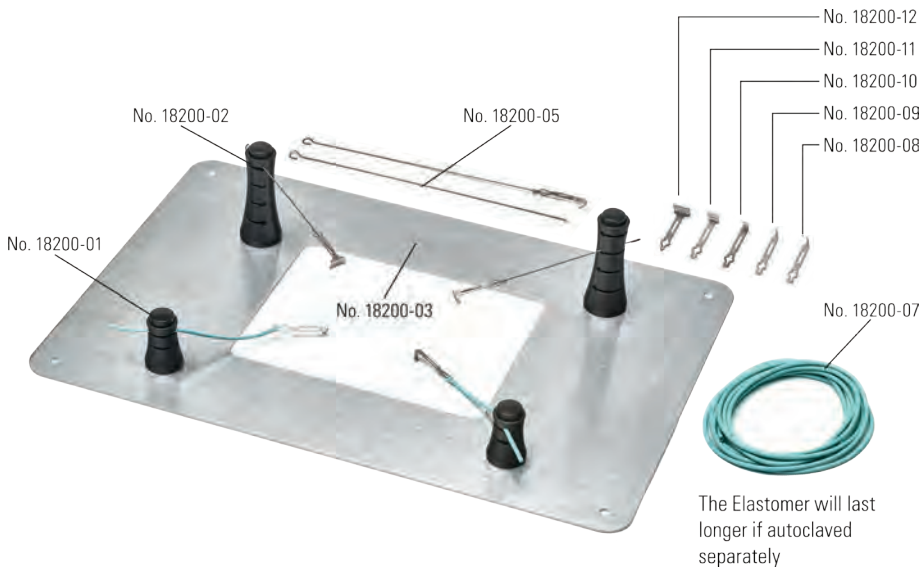

Magnetic Fixator Retraction System

This Small Animal Retraction System simplifies set-up procedure and provides the examiner with an excellent overview of the operative site. It consists of three components: Base Plate (Nos. 18200-03 & 18200-04); Fixators (Nos. 18200-01 & 18200-02); and Retractors (Nos. 18200-05 through 18200-12).

The Base Plates are made from magnetic stainless steel and are available in two sizes. The surface is nonreflective and both plates have a window in the center which allows the animal contact with body temperature control systems. The window sizes are 10 x 13 cm for the small base plate and 15 x 25 cm for the large.

The Fixators are movable anchors made from anodized aluminum with a surgical grade rare earth magnet in the base for attachment anywhere on the Base Plate. The magnets do not interfere with lab electronics and can be used in close proximity (3 cm) to ferro-magnetic items. They incorporate pushbutton-activated spring locks that grip either the Wire or Elastomer Retractors.

The Retractors are interchangeable Retractor Tips (Nos. 18200-08 through 18200-12) which attach to either Retractor Wire (Nos. 18200-05 & 18200-06) for static retraction or to Elastomer (No. 18200-07) for dynamic retraction. The Retractor Tips are light and atraumatic to delicate tissue or membrane.

All system components are autoclavable.

Kit for animals up to 200 g

Includes:

- 1 Small base plate (No. 18200-03)
- 2 Short fixators (No. 18200-01)
- 1 Tall fixator (No. 18200-02)
- 1 Elastomer, 2 m roll (No. 18200-07)
- 1 Package of retractors, blunt, 1 mm wide (No. 18200-09)
- 1 Package of retractors, blunt, 2.5 mm wide (No. 18200-10)

No substitutions

No. 18200-20

Kit for animals from 200 g up to 5 kg

Includes:

- 1 Large base plate (No. 18200-04)
- 2 Short fixators (No. 18200-01)
- 2 Tall fixators (No. 18200-02)
- 1 Elastomer, 2 m roll (No. 18200-07)
- 1 Package of retractors, blunt, 2.5 mm wide (No. 18200-10)
- 1 Package of retractors, blunt, 5 mm wide (No. 18200-11)

No substitutions

No. 18200-50

Individual parts:

Short fixator, 3 cm high
Each

No. 18200-01

Tall fixator, 6 cm high
Each

No. 18200-02

Small base plate, (20 x 30 cm)
Each

No. 18200-03

Large base plate, (25 x 35 cm)
Each

No. 18200-04

Wire handles, 10 cm long
Pkg. of 10

No. 18200-05

Wire handles, 14 cm long
Pkg. of 10

No. 18200-06

Elastomer, 2 m roll

No. 18200-07

Sharp retractors, 1 mm wide
Pkg. of 10

No. 18200-08

Blunt retractors, 1 mm wide
Pkg. of 10

No. 18200-09

Blunt retractors, 2.5 mm wide
Pkg. of 10

No. 18200-10

Blunt retractors, 5 mm wide
Pkg. of 10

No. 18200-11

Blunt retractors, 7.5 mm wide
Pkg. of 10

No. 18200-12

ACCESSORIES & INSTRUMENT CARE

Animal Accessories 163 – 168

Instrument Care & Accessories 169 – 180

Surgical Accessories 181 – 184

Laboratory Accessories 185 – 197



Reusable Gavage Feeding Needles

Stainless steel feeding needles with luer lock hub. Also ideal for transcatheter perfusions with a fixative. The needles come with a round tip.



Round tip

No. 18061-24

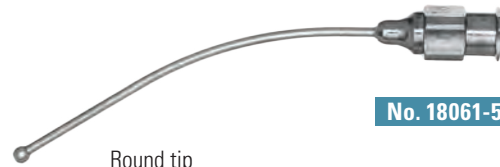

Round tip

No. 18061-50

Gauge	Length (mm)	Tip Ø (mm)	Tip Shape	Shape	Mice (g)	Rats (g)	Guinea pigs (g)	Item
24	25	1.25	Round	Straight	>14			No. 18061-24
22	25	1.25	Round	Straight	15-20			No. 18061-22
20	38	2.25	Round	Straight	20-25	50-75		No. 18064-20
20	38	2.25	Round	Curved	20-25	50-75		No. 18065-20
18	38	2.25	Round	Straight	20-30	100-200	250-300	No. 18061-38
18	50	2.25	Round	Curved	25-30	100-200	250-300	No. 18061-50
16	75	3	Round	Curved		150-300	350-450	No. 18061-75
16	100	3	Round	Curved		150-300	350-450	No. 18061-10

These needles come with a barrel tip.



Barrel tip

No. 18060-20



Gauge	Length (mm)	Tip Shape	Shape	Mice (g)	Rats (g)	Guinea pigs (g)	Item
24	25	Barrel	Straight	>14			No. 18060-24
22	25	Barrel	Straight	15-20			No. 18060-22
20	30	Barrel	Straight	20-25	50-75		No. 18060-20
20	38	Barrel	Straight	20-25	50-75		No. 18063-20
20	38	Barrel	Curved	20-25	50-75		No. 18067-20
18	38	Barrel	Straight	20-30	100-200	250-300	No. 18060-18
18	50	Barrel	Curved	25-30	100-200	250-300	No. 18067-50
16	75	Barrel	Curved		150-300	350-450	No. 18067-75
16	100	Barrel	Curved		150-300	350-450	No. 18067-10

Single Use Gavage Feeding Needles

These economical feeding needles feature plastic luer hubs with silicone tips. They are nontoxic and nonpyrogenic. Needles can be easily formed to any desired shape. **Sterile.**

Pkg. of 5 needles



No. 18061-20

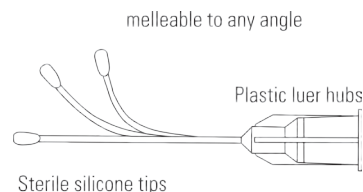

Gauge	Length (mm)	Tip Ø (mm)	Mice (g)	Rats (g)	Guinea pigs (g)	Item
20	38	1.75	20-25	50-75		No. 18061-20
18	50	2.5	25-30	100-200		No. 18061-18
15	75	3		200-350	400-600	No. 18061-15

Disposable Flexible PTFE Feeding Needles

These affordable needles feature flexible PTFE tube with silicone tip and plastic luer hub, delivered in sterile pouches. They are very flexible, and translucent for easy confirmation of reagent delivery. The soft silicone tips are non-toxic and non-pyrogenic and ensure that no damage occurs during the insertion. **Sterile.**

Pkg. of 5 needles



No. 18961-85



No. 18961-75



No. 18961-15



No. 18961-17



No. 18961-18



No. 18961-20

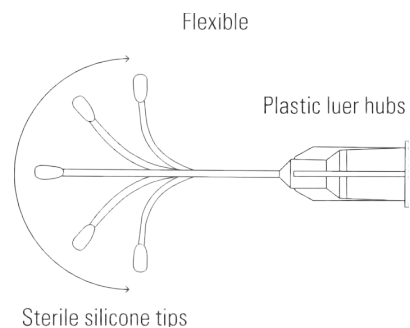

Gauge	Length (mm)	Tip Ø (mm)	Mice (g)	Rats (g)	Guinea pigs (g)	Item
20	38	1.8	20-25	50-75		No. 18961-20
18	38	2	20-30	100-200	250-300	No. 18961-18
17	52	2.4	25-30	100-200	250-300	No. 18961-17
15	78	2.6		200-350	400-600	No. 18961-15
18	75	2	25-30	150-250	250-300	No. 18961-75
17	85	2.4	25-30	150-250	250-300	No. 18961-85

GenoPunch

The interchangeable GenoPunch aids in the fast and simple collection of the 2 mm tissue sample for DNA analysis and/or genotyping. FST Exclusive Item. **Autoclavable.**



Microtubes not included.

GenoPunch includes

- 1 GenoPunch
- 1 0.5 ml tube holder
- 1 1.6 ml tube holder
- 1 Screwdriver
- 4 Screws

FST does not supply microtubes.



11.5 cm
Stainless Steel and
Anodized Aluminum
Punch Ø: 2 mm

No. 24215-02

Blue Ear Punch

The Ear Puncher relieves stress on the wrist during ID marking as it requires only a very gentle pressure to cut a hole. The stainless steel puncher has a sloped edge that provides a cut rather than a punch, which minimizes discomfort. The ear puncher should be lubricated to improve longevity. **Autoclavable.**



Microtubes not included.

14 cm
Punch Ø: 1 mm

No. 24916-01

14 cm
Punch Ø: 2 mm

No. 24916-02

ANIMAL ACCESSORIES

EAR PUNCHES

Ear Punch with Replaceable Tip

Designed to ensure a fast and clean punch, this ear punch is lightweight and fits comfortably in the palm of your hand. The tip is replaceable. **Autoclavable.**



Handle and Tip

11.5 cm
Anodized aluminum handle
and stainless steel tip
Punch Ø: 2 mm

No. 24213-02

Replacement Tip

Punch Ø: 2 mm

No. 24213-12

Ear Punch

Designed to ensure a fast and clean punch, this ear punch is lightweight and fits comfortably in the palm of your hand. FST Exclusive Item. **Autoclavable.**



11.5 cm
Stainless Steel and anodized
aluminum
Punch Ø: 2 mm

No. 24214-02

Finger Loop Ear Punch

This ear punch provides stability and control for researchers using the numbering system. The 1 mm ear punch offers greater numbering variations and/or patterns.



10.5 cm
Punch Ø: 2 mm

No. 24212-02

Punch Ø: 1 mm

No. 24212-01

Marking Pen

The Marking Pen was developed for easy, long lasting identification of laboratory animals. The markers contain no harmful chemicals and instead nontoxic pigment approved by the Japanese Ministry of Health for use in food, drugs and cosmetics. It is intended for use on the fur and not the skin and will last for 6-12 weeks.



CAUTION: Color can stain skin and clothing. The use of gloves and lab coats is recommended. These colors will not work on black fur.



Fine Tip
4.5 x 7.5 mm
Black
10 ml

No. 24202-06



Fine Tip
4.5 x 7.5 mm
Blue
10 ml

No. 24202-02



Fine Tip
4.5 x 7.5 mm
Green
10 ml

No. 24202-01



Fine Tip
4.5 x 7.5 mm
Red
10 ml

No. 24202-04



Fine Tip
4.5 x 7.5 mm
Yellow
10 ml

No. 24202-03



Fine Tip
4.5 x 7.5 mm
Orange
10 ml

No. 24202-05



Standard Tip
15 x 10 x 10 mm
Black
15 ml

No. 24202-16



Standard Tip
15 x 10 x 10 mm
Blue
15 ml

No. 24202-12



Standard Tip
15 x 10 x 10 mm
Green
15 ml

No. 24202-11



Standard Tip
15 x 10 x 10 mm
Red
15 ml

No. 24202-14



Standard Tip
15 x 10 x 10 mm
Yellow
15 ml

No. 24202-13



Standard Tip
15 x 10 x 10 mm
Orange
15 ml

No. 24202-15

Surgical Skin Marker

This marker features a versatile tip for precise fine (0.2 mm) line marking, or when held at an angle, a broad (2 mm) line marking. The marker's violet ink is nontoxic, non-tattooing and surgical prep-resistant.

Markings can be removed from the skin with isopropyl alcohol. A six-inch ruler calibrated in both centimeters and inches is included.



No. 18000-30

50% of actual size

Self Piercing Ear Tags

These ear tags come numbered from 1-1000. The silver colored ear tags are made of monel and the laser marked numbers provide high visibility making them easy to read. Once applied, tags seal and cannot be removed, providing an easy to use, permanent identification method. These ear tags are safe for use in salt water.



80% of actual size

Applicator
14 cm

No. 24220-00



Custom alphanumeric sequences and numbers above 1000 are available by special order.

Customized ear tags available in packages of 100 or 500. The following markings are possible: 1 to 6 numbers only or 1 to 6 letters and numbers.

For special order, use item No. 70000-10 and indicate sequence. Please allow 4 to 5 weeks for delivery.



Picture similar

Alloy: Monel
0.8 cm
No. 1-100
Ear tags - #s 1 to 100

No. 24221-10

Alloy: Monel
0.8 cm
No. 1-500
Ear tags - #s 1 to 500

No. 24221-50

Alloy: Monel
0.8 cm
No. 501-1000
Ear tags - #s 501 to 1000

No. 24221-90

Animal Microtattoo System

A quick, efficient and affordable method of permanently identifying laboratory animals (mice as early as 1 day old). Designed and tested by laboratory animal technicians, the system utilizes a hypodermic needle at one end of a stainless steel forceps and a small metal cup containing green tattoo paste at the other side of the forceps.

By squeezing the forceps together, the needle penetrates the toe, footpad or ear of the animal and injects a deposit of green tattoo paste into the animal. A grid location pattern provided enables a numbering system that extends over 1 million.

Use of the microtattoo system is humane and in compliance with regulatory agencies for the care and use of laboratory animals. Detailed instructions are included.

Both the microtattoo forceps and green tattoo paste are autoclavable.

Animal microtattoo system (No. 24201-00) includes:

- 1 Pair plated steel microtattoo forceps
- 1 Tube (1 oz.) of green tattoo paste
- 1 Aluminum planchette
- 2 Hypodermic needles
- 1 Plastic holding case



Animal microtattoo system
13 cm

No. 24201-00



Green tattoo paste
29.6 ml

No. 24201-01

Fine Forceps Repair Kit

Realign and repair fine forceps with this convenient kit. Bent forcep tips can be restraightened with the chain nose pliers. The sharpening stone has two grooves, 1.6 mm and 0.8 mm, to assist in resharpener the forcep tips. O-rings clamp the forceps shut to ensure that both shanks are equally aligned and sharpened. Instrument oil assists in producing a smooth sharp edge. Detailed instructions are included.



Kit includes:

- 1 Sharpening stone for fine forceps with ten O-rings (No. 29008-22)
- 1 Instrument oil, 50 ml bottle (No. 29055-00)
- 1 Chain nose pliers

No. 29000-00



O-Rings for Forceps

These rubber O-rings fit our forceps and keep them closed with variable degrees of pressure on the tips.

Pkg. of 10

No. 11200-00



Instrument Oil

Physiologically inert oil for lubricating surgical instruments, box locks, ratchets and any overlapping joints.

50 ml bottle

No. 29055-00

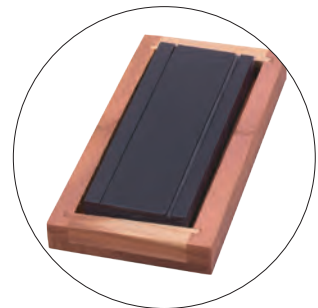

Sharpening Stone for Fine Forceps

This natural Arkansas stone assists in resharpener the tips of fine forceps. The stone has two grooves, 0.8 mm and 1.6 mm and comes in a cedar box with ten O-rings.

12.5 x 6.5 x 3 cm

No. 29008-22

INSTRUMENT CARE & ACCESSORIES

Instrument Marking Tape

Organize instruments quickly and easily with this economical, non-toxic, pressure sensitive tape. Color is unaffected by boiling, cold sterilization or autoclaving. 8 colors available. **Autoclavable.**



Color	Roll length (cm)	Tape width (cm)	Material	Item
Green	290	0.6	Vinyl	No. 29071-01
Blue	290	0.6	Vinyl	No. 29071-02
Yellow	290	0.6	Vinyl	No. 29071-03
Red	290	0.6	Vinyl	No. 29071-04
White	290	0.6	Vinyl	No. 29071-05
Black	290	0.6	Vinyl	No. 29071-06
Orange	290	0.6	Vinyl	No. 29071-08
Purple	290	0.6	Vinyl	No. 29071-09

**Instrument Marking Tape
8 Assorted Colors**

Organize instruments quickly and easily with this economical, non-toxic, pressure sensitive tape. Color is unaffected by boiling, cold sterilization or autoclaving. Includes 8 assorted color rolls: Yellow, Red, Black, White, Green, Brown, Purple, Blue and Orange. **Autoclavable.**

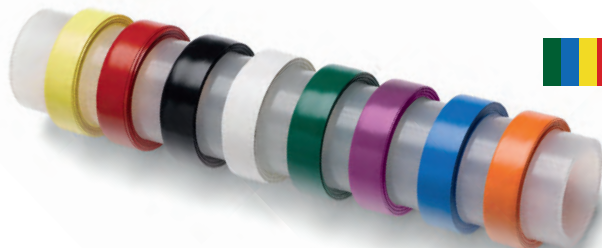

	107	0.6	Vinyl	No. 29080-01
--	-----	-----	-------	---------------------

Instrument Marking Tape

Organize instruments quickly and easily with this economical, non-toxic, pressure sensitive tape. Color is unaffected by boiling, cold sterilization or autoclaving. 9 colors available. **Autoclavable.**



Color	Roll length (cm)	Tape width (cm)	Material	Item
Green	510	0.6	Vinyl	No. 29070-01
Blue	510	0.6	Vinyl	No. 29070-02
Yellow	510	0.6	Vinyl	No. 29070-03
Red	510	0.6	Vinyl	No. 29070-04
White	510	0.6	Vinyl	No. 29070-05
Black	510	0.6	Vinyl	No. 29070-06
Brown	510	0.6	Vinyl	No. 29070-07
Orange	510	0.6	Vinyl	No. 29070-08
Purple	510	0.6	Vinyl	No. 29070-09

Self Sealing Sterilization Pouches

Preformed pouches with self adhering tape are blue tinted on one side for visualization of contents and paper-backed on the other side. Pouches will work with either steam autoclave or ethylene oxide sterilization.

Material properties:

- Protects instruments during sterilization.
- Provides sterile storage until use.
- Write on pouches for easier identification during sterilization.



10 x 18 cm

For instruments up to 13 cm long

Pkg. of 100 pouches

No. 28000-07

13 x 26 cm

For instruments up to 23 cm long

Pkg. of 100 pouches

No. 28000-10

18 x 30 cm

For instruments up to 26 cm long

Pkg. of 100 pouches

No. 28000-12

HOT BEAD STERILIZER

Hot Bead Sterilizer

The sterilizer provides a safe, effective and convenient method for sterilizing your surgical instruments prior to and during surgery or tissue culture. Without using potentially dangerous gases flames or chemicals, you can ensure that your instruments will be free of pathogens and microbial contaminants.

The beads take 15–20 minutes to reach 240°C to 270°C (464°F to 518°F), then the sterilizer is ready for use. The temperature is thermostatically maintained and the unit can be left on all day. Instruments require approximately 20 seconds of contact with the beads for complete sterilization. The sterilizer is safe to use even in laminar flow hoods.

Sterilization test results conducted by the Pasteur Institute in Lille, France, are available upon request. Available in 110V and 220V. CE Certified and UL Approved.

Sterilizer includes:

- Sterilizer unit
- 1 Bag of glass beads
- 1 Dust cover for well
- 1 Small heat-tempered glass dish for small objects (only with FST 250)

FST 250 shown.
Instruments not included.

60 % of actual size



FST 250 Sterilizer

Well Ø: 4 cm
Well depth: 8 cm
Well volume: 100 ml
Total unit size: 14.5 x 12.5 x 13.5

No. 18000-45

FST 350 Sterilizer

Well Ø: 4 cm
Well depth: 14 cm
Well volume: 175 ml
Total unit size: 20.5 x 12.5 x 13.5

No. 18000-50

Replacement glass beads for FST 250

Weight: 150 g

No. 18000-46

Replacement glass beads for FST 350

Weight: 300 g

No. 18000-51

Micro Bead Sterilizer with Glass Beads

Micro Bead Sterilizer is ideal for the sterilization of small and large research tools (forceps, scissors, etc.). When the chamber is filled with the included glass beads, high temperatures (up to 300° C) can be used to eliminate the presence of bacteria, spores and other micro-organisms.

Small Sterilizer 110V

Well Ø: 4 cm
Well depth: 8 cm
Well volume: 100 ml
Total unit size: 14.5 x 15.5 x 15.5 cm

No. 18090-45**Small Sterilizer 220V**

Well Ø: 4 cm
Well depth: 8 cm
Well volume: 100 ml
Total unit size: 14.5 x 15.5 x 15.5 cm

No. 18090-46**Replacement glass beads for small sterilizer**

Weight: 150 g

No. 18000-47**Tall Sterilizer 220V**

Well Ø: 4 cm
Well depth: 14 cm
Well volume: 175 ml
Total unit size: 14.5 x 15.5 x 21.5 cm

No. 18090-51**Tall Sterilizer 110V**

Well Ø: 4 cm
Well depth: 14 cm
Well volume: 175 ml
Total unit size: 14.5 x 15.5 x 21.5 cm

No. 18090-50

Small sterilizer shown.
Instruments not included.

60 % of actual size

**Replacement glass beads for tall sterilizer**

Weight: 300 g

No. 18000-52

Autoclave Tape

Tape will permanently indicate diagonal stripes after exposure to steam autoclave temperature between 121°C and 130° C during a 40-60 minute time period. Use with sterilization pouches, sterilization wraps and sterilization cases.

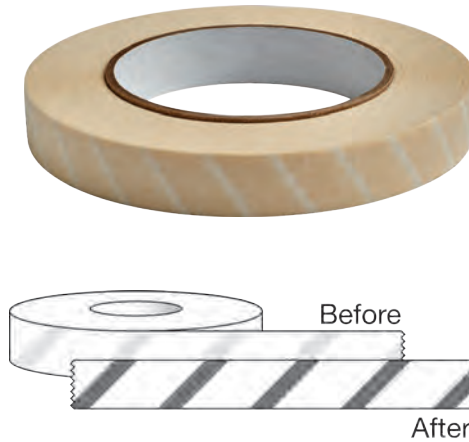

2 cm x 55 m

No. 28001-02

Disposable Sterilization Wraps

These biodegradable cellulose fiber wraps are resistant to tears and conform easily to maintain a breathable yet impervious barrier to airborne bacteria, saline, blood and water. Wrapping your instrument case securely will ensure the sterility of your instruments until ready for use. Available in two sizes.

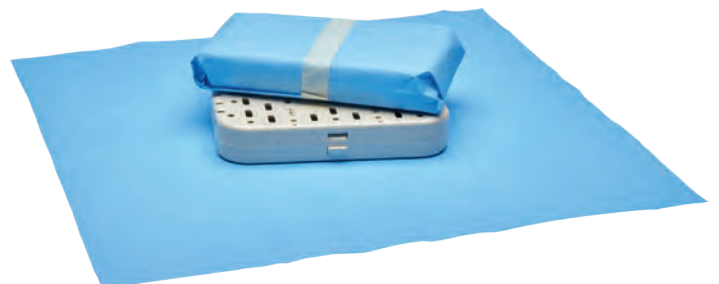
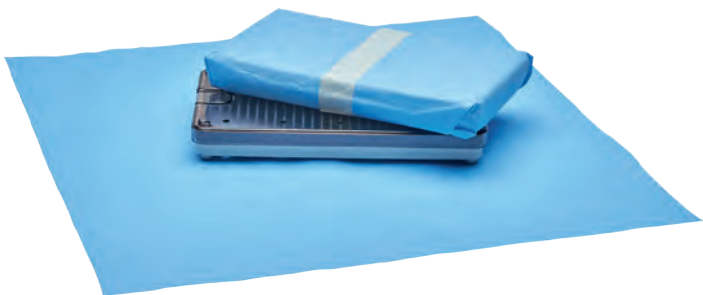

Cases not included.

38 x 38 cm
Pkg. of 25 wraps

No. 28015-15

51 x 51 cm
Pkg. of 25 wraps

No. 28020-20

INSTRUMENT CARE
& ACCESSORIES

Silicone Mat

High quality, extra soft mat for safe and secure placement of delicate instruments. This mat can easily be cut along the premarked grooves to fit in various sized instrument cases. **Autoclavable.**



30 x 20 cm

No. 20325-00**Magnetic Sterilization Mat**

Used during sterilization and for safe anti-slip placement around surgical settings. **Autoclavable.**



Instruments not included.

30 x 20 cm

No. 20350-00**Silicone Mat**

Large, economical silicone mat. **Autoclavable.**

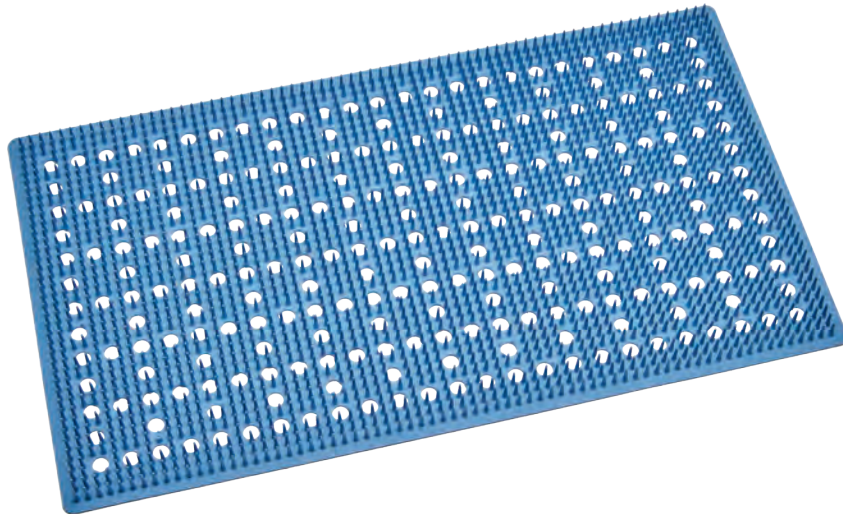

46 x 25 cm

No. 20325-10

Sterilization Container

This plastic sterilization container includes a silicone mat for safe placement of instruments. Perforated top is clear for visual identification of instruments. **Suitable for autoclave or ethylene oxide sterilization.**



19 x 10 x 2 cm
No. 20810-01

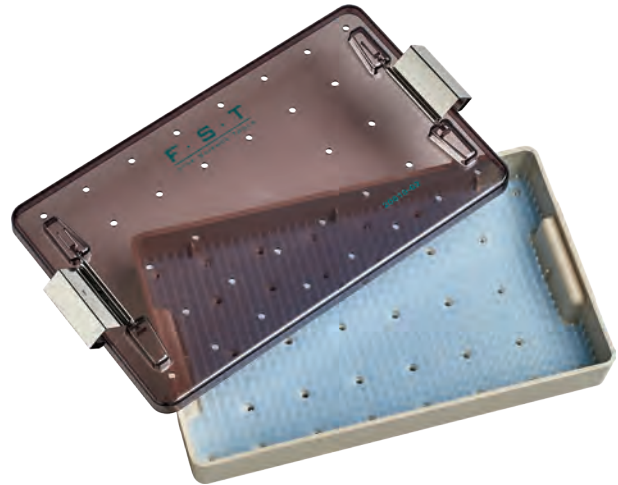

27 x 16 x 4 cm
No. 20810-02

Two Tiered Sterilization Container

This plastic sterilization container has two tiers of silicone slots that will accommodate up to 12 different instruments. Hinged top and bottom lock tight. Container is perforated. **Suitable for autoclave or ethylene oxide sterilization.**



25 x 12 x 3 cm
No. 20820-00

INSTRUMENT CARE & ACCESSORIES

Sterilization Container

This sterilization container is made from Ultem® polymer to ensure strength and long lasting durability. The transparent perforated lid provides easy identification of your surgical instruments. Silicone mat is included for a safe and secure hold. Trays are also stackable for convenience. **Suitable for autoclave or ethylene oxide sterilization.**



20840-03

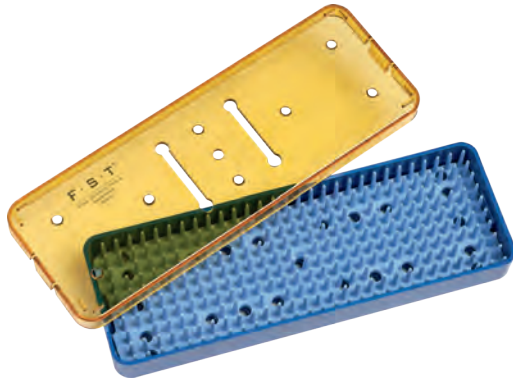

19 x 7 x 2 cm
Single tier

No. 20840-01

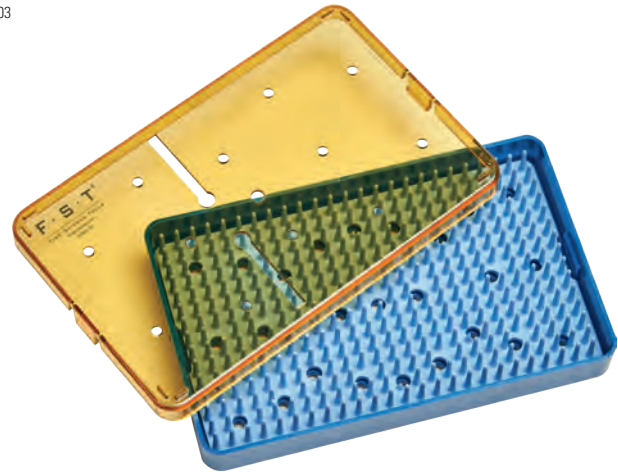

17 x 10 x 2 cm
Single tier

No. 20840-02

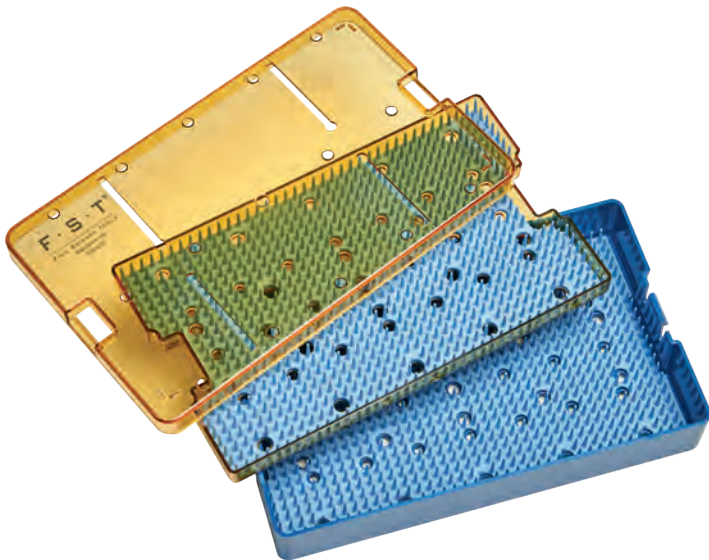

25 x 15 x 4 cm
Double tier

No. 20842-03

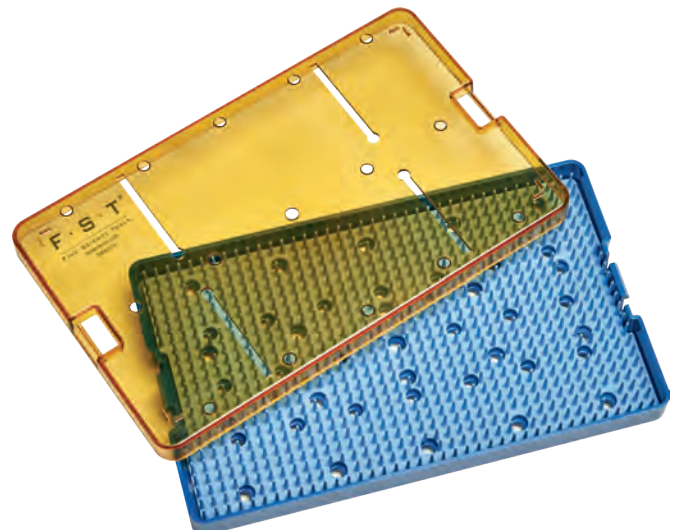

25 x 15 x 2 cm
Single tier

No. 20840-03

Dual Clasping Stainless Steel Sterilization Container

This container will assist in the sterilization and storage of your fine surgical instruments. It comes with a custom fit silicone mat to keep instruments in place while the sterilizing process and storage. The textile filters are necessary for keeping instruments sterile while they remain in the container.

Suitable for autoclave or ethylene oxide sterilization.



30 x 14 x 4 cm

No. 20850-00

5 Long-term textile filters

No. 20850-10

One Long-term textile filter

No. 20850-11

Utility Instrument Case

Comes with a silicone mat for safe placement of instruments. **Case and silicone insert are autoclavable but should not be used for sterilizing surgical instruments.**



18 x 9 x 3 cm
Silver

No. 20311-21

INSTRUMENT CARE & ACCESSORIES

Colored Aluminum Cases

This instrument case comes with a spiked silicone mat for secure storage of surgical instruments. Four colors available but may vary due to lot to lot variations.

The case and silicone insert are autoclavable but should not be used for sterilization of surgical instruments.



18 x 9 x 3 cm
Blue

No. 20330-00



18 x 9 x 3 cm
Green

No. 20330-01



18 x 9 x 3 cm
Red

No. 20330-02



18 x 9 x 3 cm
Yellow

No. 20330-03

Instrument Case

This plastic case is compact, safe, secure, and slotted for placement of individual surgical instruments, aiding in the prevention of tip damage. Seven colors available. **Case is autoclavable but should not be used for sterilizing surgical instruments.**



Instruments not included.



17 x 8 x 2 cm
Blue

No. 20830-00



17 x 8 x 2 cm
Green

No. 20830-01

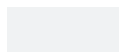

17 x 8 x 2 cm
Clear

No. 20830-02



17 x 8 x 2 cm
Yellow

No. 20830-03



17 x 8 x 2 cm
Pink

No. 20830-04



17 x 8 x 2 cm
Orange

No. 20830-05



17 x 8 x 2 cm
Purple

No. 20830-06

INSTRUMENT CARE & ACCESSORIES

INSTRUMENT STORAGE

Roll Up Travel Case

Vinyl dissection roll up case with Velcro strap to hold the case closed. Holds up to 10 tools, one ruler holder, and one Velcro sealed pouch. **Instruments not included.**

36 x 23 cm (unfolded)

Black

Vinyl

No. 20831-10



Instrument Tip Protectors

These tip protectors are a convenient, color-coded way to protect surgical instrument tips and edges. They provide exceptional protection and are vented to prevent rusting from condensation. Instrument tip protectors are recommended during handling, storage and sterilization. **Autoclavable.**



1.6 x 19.1 mm
Pkg. of 25
Material: Plastisol

No. 29060-01



2 x 19 mm
Pkg. of 25
Material: Plastisol

No. 29060-02



2.8 x 19.1 mm
Pkg. of 25
Material: Plastisol

No. 29060-03



3.2 x 25.4 mm
Pkg. of 25
Material: Plastisol

No. 29060-04



29060-00



4.8 x 25.4 mm
Pkg. of 25
Material: Plastisol

No. 29060-05



9.5 x 25.4 mm
Pkg. of 25
Material: Plastisol

No. 29060-06

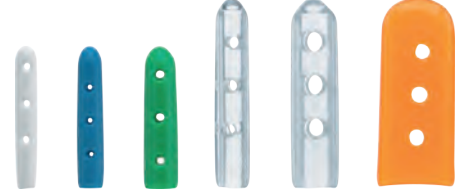

Assorted pack, five of each size
Pkg. of 30
Material: Plastisol

No. 29060-00

Double Tip Protectors

These vented tip protectors are designed to hold hemostats and rongeurs firmly while allowing the jaws, box hinge and tips to stay open for thorough sterilization. **Autoclavable.**



12.7 x 2 mm
Pkg. of 10
Material: Plastisol

No. 29066-01



9 x 25.5 mm
Pkg. of 10
Material: Plastisol

No. 29066-02



15 x 25 mm
Pkg. of 10
Material: Plastisol

No. 29066-03



25 x 26 mm
Pkg. of 10
Material: Plastisol

No. 29066-04



Assorted pack,
three of each size
Pkg. of 12
Material: Plastisol

No. 29066-00

Stainless Steel Burrs

Length: 44 mm
 Shaft Ø: 2.3 mm
 Pkg. of 10 burrs

Tip Ø (mm)	Item
0.7 *	No. 19008-07
0.9 **	No. 19008-09
1.4	No. 19008-14

* Use this size for screws No. 19010-10 (page 64).
 ** Use this size for screws No. 19010-00 (page 64).



Carbon Steel Burrs

Length: 44 mm
 Shaft Ø: 2.3 mm
 Pkg. of 10 burrs



19007-07

Tip Ø (mm)	Item
0.5	No. 19007-05
0.7 *	No. 19007-07
0.9 **	No. 19007-09
1.4	No. 19007-14
2.1	No. 19007-21
2.9	No. 19007-29

* Use this size for screws No. 19010-10 (page 64).
 ** Use this size for screws No. 19010-00 (page 64).



Tungsten Carbide Burrs

Length: 44 mm
 Shaft Ø: 2.3 mm
 Pkg. of 5 burrs



Tip Ø (mm)	Item
0.5	No. 19009-05
0.7 *	No. 19009-07
0.9 **	No. 19009-09

* Use this size for screws No. 19010-10 (page 64).
 ** Use this size for screws No. 19010-00 (page 64).



Stainless Steel Trephines

Side opening for clearing of material.

Length: 44 mm
 Shaft Ø: 2.3 mm
 Sold individually

1.8 - 2.7 mm 5 mm

Tip Outer Ø (mm)	Item
1.8	No. 18004-18
2.3	No. 18004-23
2.7	No. 18004-27
5	No. 18004-50



Stainless Steel Circular Saw

For cutting bone and other hard substances. Attaches to mandrel (No. 18000-18), on the right side.



Ø: 1.6 cm
 Thickness: 0.1 mm
 Pkg. of 10 saws

No. 18000-20

Stainless Steel Mandrel

Screw allows attachment of discs and circular saws for use with high speed drills.



Length: 45 mm
 Shaft Ø: 2.3 mm

No. 18000-18

High Temperature Cautery Kit

This high temperature cauterizer is a great alternative to disposable cautery units. Temperature at tips is approximately 1000°C (1832°F). Replacement cautery tips are available. **Not autoclavable.**



Plastic body
 Stainless steel tips: 0.2 mm Ø
 Operation temperature: 1000°C (1832°F)
 Total weight: 70 g
 Length: 16 cm (without tip)

- Cautery kit includes:
- 1 Cautery handle
 - 2 AA batteries
 - 2 Standard tips
 - 1 Storage case
 - 2 Fine tips

65% of actual size

Low Temperature Cautery Kit

This low temperature cautery kit is a great alternative to disposable cautery units. Temperature at the tips is approximately 649°C (1200°F). Replacement cautery tips are available. **Not autoclavable.**



Plastic body
 Stainless steel tips: 0.2 mm Ø
 Operation temperature: 649°C (1200°F)
 Total weight: 60 g
 Length: 12 cm (without tip)

- Cautery kit includes:
- 1 Cautery handle
 - 1 AA battery
 - 2 Fine tips
 - 1 Storage case
 - 2 Elongated fine tips



Replacement tips
Single use
 Straight / Standard
 Sterile: Yes

Box of 10 tips

No. 18010-00



Replacement tips
Single use
 Straight / Fine
 Sterile: Yes

Box of 10 tips

No. 18010-02



Replacement tips
Single use
 Straight / Fine
 Sterile: Yes

Box of 10 tips

No. 18019-01



Replacement tips
Single use
 Elongated Straight / Fine
 Sterile: Yes

Box of 10 tips

No. 18019-02

Small Vessel Cauterizer

This small hand-held unit keeps bleeding to a minimum and therefore provides a surgical field clear of clamps and hemostats. The cauterizer should be activated momentarily so the delicate tips do not burn out. Temperature at tips is approximately 1000°C (1832 °F). Replacement cautery tips are available. **Autoclavable.**



Heavy gauge stainless steel body
Platinum-iridium tips: 0.3 mm Ø
Total weight: 100 g
Length: 13.5 cm (without tip)

Cautery kit includes:

- 1 Cautery handle
- 2 AA Batteries
- 1 Straight fine tip
- 1 Storage case
- 1 Angled fine tip



Remove batteries before autoclaving.

80% of actual size



Replacement tip
Reusable
Straight / Fine

Cautery Kit

No. 18000-00



Replacement tip
Reusable
Angled / Fine

No. 18000-02



Replacement tip
Reusable
Straight / Fine

No. 18000-03



Replacement tip
Reusable
Straight knob

No. 18000-04

Neuro Punches

N.I.H. style neuro punches for punch removal of frozen brain microregions.



ID (mm)	OD (mm)	Gauge	Length (cm)	Item
0.31	0.61	24	4.2	No. 18036-24
0.41	0.7	22	4.5	No. 18036-22
0.69	1	19	4.5	No. 18036-19

Absorption Spears and Triangles

These synthetic surgical sponges absorb fluids twice as fast as the best cotton sponges and have three times their fluid-holding capacity. They are made from strong, soft, lint-free biocompatible-proven material that is nonirritating to delicate tissue and leaves no fibrous residue that might cause wound contamination. The Absorption Spears are sterilized by radiation.



Absorption Spears
7 cm
Sterile: Yes
Pkg. of 200 spears

No. 18105-01



Absorption Triangles
2 cm
Sterile: Yes
Pkg. of 200 triangles

No. 18105-04

Sample Corers

For quantitative analysis. Comes with plunger.

8.5 cm

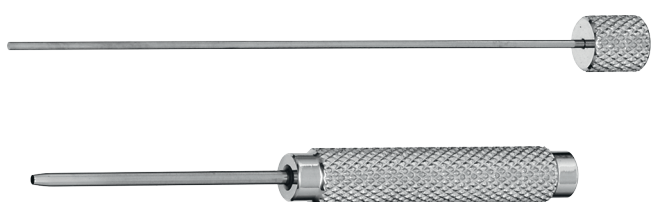

ID (mm)	OD (mm)	Gauge	Item
0.35	0.8	21	No. 18035-35
0.5	1	19	No. 18035-50
0.8	1.45	17	No. 18035-80
1	1.8	15	No. 18035-01
2	3	11	No. 18035-02
3	4	8	No. 18035-03
5	6	4	No. 18035-05

Fiber Optic Swabs



Straight
15 cm
Tip Ø: 2.5 mm
Pack of 100

No. 18106-01

Micro Cleaning Brush



7 cm
Nylon
Bag of 25

No. 18196-10

SURGICAL ACCESSORIES

Miniature File Set

Comes with 8 different file profiles in a vinyl pouch.



10 cm
Carbon Steel

No. 30076-14

Instrument Sharpening Stones

Natural Arkansas oil stones feature unequalled fineness, hardness and structural density. When used with mineral oil, they will produce a sharper cutting edge.



6 mm x 9 cm
Square stone

No. 29008-01



6 mm x 9 cm
Triangular stone

No. 29008-12

4-in-1 Screwdriver

With 4 hardened, interchangeable blades stored in handle: 1.5, 2, 2.5, and 3 mm.



Handle 9.5 cm, with attachment 11.5 cm
Nickel handle

No. 30051-10

Ceramic Blade Cutter

Ceramic edge stays sharp 100 times longer than a steel edge. Rust and corrosion free. No trace metal contamination. **Autoclavable.**



Straight
13 cm
Cutting Edge: 58 mm

No. 10025-70

Replacement blade

Straight
Cutting Edge: 58 mm

No. 10025-71

LABORATORY ACCESSORIES

Utility Scissors

These scissors are extremely hard (54 on the Rockwell scale). Useful for cutting tin or aluminum sheets, bone, plastics, etc. The strong, 3 mm thick blades are magnetic. The plastic handles are anatomically shaped.



75% of actual size

21 cm
Stainless steel with plastic handle

No. 37500-00

Universal Scissors

The scissor blades are made of high quality stainless-steel and guarantee a perfect cut. Handles are made of glass fiber reinforced polyamide.



13 cm
Stainless steel with plastic handle

No. 37500-05

Ruler with Gauge Measurements

Front

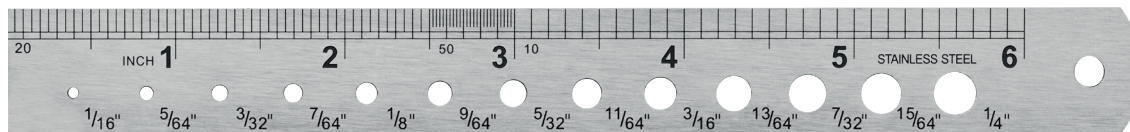

Back

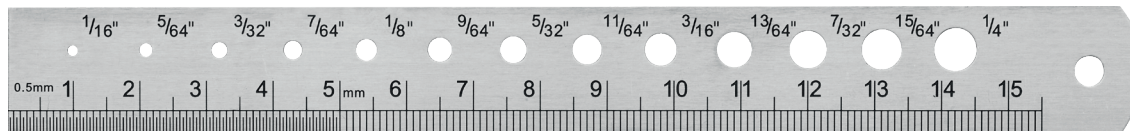

Stainless Steel
15 cm / 6"

No. 30085-15

Ruler with Metric Conversion Table

Front



Back



Stainless Steel
30 cm / 12"

50% of actual size

No. 30085-30

Ruler Label

Used for stable measurements in all surgical platforms.



6 cm
Pkg. of 25 labels

No. 29027-00

CALIPERS

Plastic Vernier Caliper

Tough polymer is unbreakable under normal conditions. Measures inside, outside, step and depth, metric and inch to 0.1 mm or 1/64".
Maximum measurement: 153 mm.

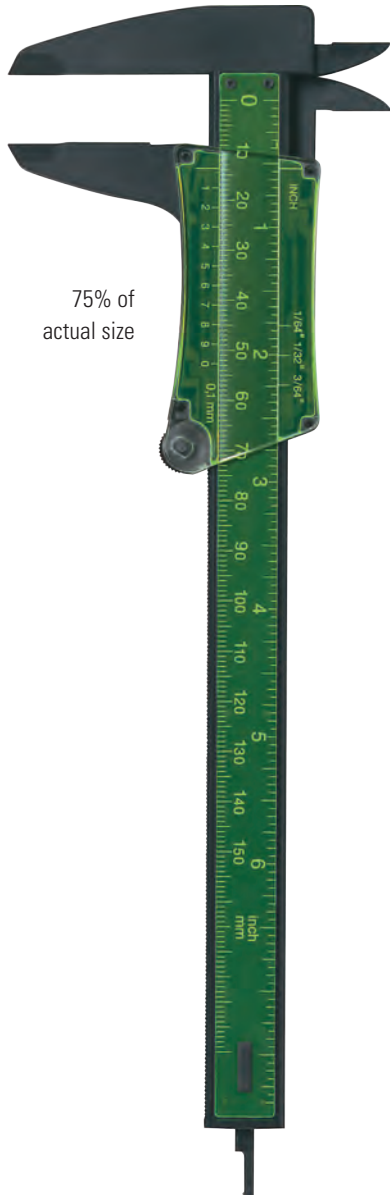

75% of
actual size

Plastic
21 cm

No. 30087-20

Digital Electronic Caliper

Wide screen LED display with the ability to measure in millimeters, inches and fractions. Measures inside, outside, step and depth. Battery, spare battery and plastic storage case included.

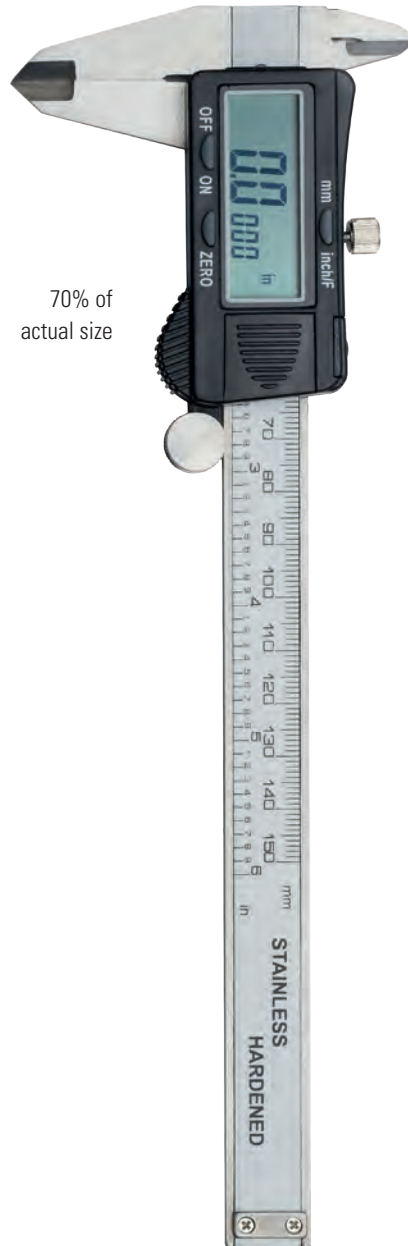

70% of
actual size

Stainless steel
23.5 cm

No. 30087-00

Castroviejo Surgical Caliper

Used for precise measurement during surgery.



0-20 mm with 0.5 mm divisions
Tip Ø: 0.5 mm

8.5 cm

No. 18000-35

Magnifying Loupe with Micrometer and LED

High quality loupe features a removable micrometer and ultra-bright LED lights surrounding the circumference for a defined image and clear contrast.

Magnification: 10x
Field of view: 30 mm
Working distance: 10 mm (without scale)
Ultrabright LED

38 x 38 x 40 mm

No. 29026-10

**Stage Micrometers**

These are highly accurate stage micrometers for use with transmitted light in both compound and stereo microscopes. Comes with a plastic case.

76 x 26 mm
10 mm with 100 divisions (0.1 mm)

No. 29025-01

76 x 26 mm
1 mm with 100 divisions (0.01 mm)

No. 29025-02



Electronic Clock/Triple Timer

Three activities can be timed up or down simultaneously or individually. Time can be displayed either in 12 or 24 hours and features a memory function. Maximum countdown time is 19 hours, 59 minutes, 59 seconds. Minimum time interval is 1 second. The timer housing includes a powerful magnet for mounting.

LCD display: 4.5 x 4.5 cm
7 x 8.5 x 1.5 cm
AA battery (not included)

No. 27000-01



Gold Wire Contacts

Matching pin and socket. Contacts are crimp terminated, but also can be used for solder connections.

Enlarged 225%

Total length: 16 mm (if connected)
Ø:1.2 mm
Opening for wire: 0.63 mm

Pkg. of 50 Male contacts

No. 19003-00

Pkg. of 50 Female contacts

No. 19003-01

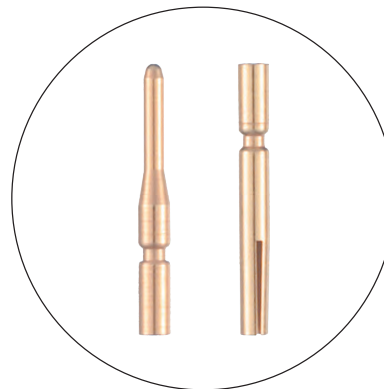

Headband Magnifier

Precision ground and polished optical glass lenses. The padded headband is lightweight and fully adjustable. Can be worn with spectacles.



Headband magnifier shown with VisorLIGHT™ (sold separately).

Magnification: 2.5x
Working distance: 20 cm (8")

No. 28030-02

Magnification: 2.75
Working distance: 15 cm (6")

No. 28030-03

Magnification: 3.5x
Working distance: 10 cm (4")

No. 28030-04

VisorLIGHT™

Small, portable light source with 26 cm cord for attachment to headband. It comes with a battery pack that holds two AA batteries. Completely adjustable. Replacement bulbs are available upon request.



AA battery (not included)

No. 28030-10

Interchangeable Magnifier Headset with LED

Economical and fully interchangeable headband magnifier with LED light.

Includes:

- Multiple Lens Magnifications (1.0x, 1.5x, 2.0x, 2.5x, 3.5x)
- LED Light Source
- Tilting Functionality
- Cushioned Nose Pads
- Adjustable Headband
- Interchangeable Lens Frames
- Requires 3 AAA Batteries (Batteries not included)



Can be used with or without the adjustable head strap (included).



Magnification: 1x, 1.5x, 2x, 2.5x and 3.5x
 Field of view: Variable
 Working distance: Variable

No. 28080-10

Galilean Loupes

These loupes are lightweight and easy to use. Made from the finest optical coated lenses which deliver excellent clarity and high resolution. The loupes are mounted onto a strong yet flexible wraparound safety frame with a headband for stability and comfort. Ability to flip loupes up for use as safety glasses. Comes with mini screwdriver for fine adjustments, micro cloth and storage case.



Magnification: 3x
Working distance: 40 cm (16")
Weight: 72 g

No. 28050-30

Magnification: 3.5x
Working distance: 30 cm (12")
Weight: 77 g

No. 28050-35

Eschenbach Magnifier Spectacles

These magnifier spectacles allow full adjustments on almost all parts. Headband keeps spectacles steady and in place. Leather case and Headband included.



Magnification: 2.5x
Working distance: 35 cm (14")
Weight: 70 g
Plastic frame reinforced with fiberglass

No. 28040-30

Spectacles Headband

Compatible with the Eschenbach Max Detail Spectacles (Item No. 28030-20) and Eschenbach Magnifier Spectacles (Item No. 28040-30).



Material: Neoprene

No. 28080-90

Eschenbach Max Detail Spectacles

These spectacles are portable, lightweight, and easily adjustable. Designed with frosted objective lens housing which eliminates distracting reflections. Bendable ear pieces for a secure, comfortable fit. Protective case is included.



Magnification: 2x
 Field of view: 110 mm (4")
 Working distance: 40 cm (16")
 Weight: 49 g

Max Detail Spectacles shown with Eschenbach Clip-On LED Light (sold separately).

No. 28030-20

Eschenbach Clip-On LED Light

A compact and lightweight light source with two high-performance SMD LED's and a lens that concentrates the light producing a more powerful, bright and homogenous field of view. Light can be set high or low. Compatible with the Max Detail Spectacles and Head-band Magnifiers. Comes with 3 AA batteries, belt clip and storage case.



Weight: 106 g (incl. batteries)

No. 28030-25

Eschenbach Vario Flex with LED

The Vario LED Flex ensures ease and precision by its smooth flexible neck and tiltable magnifying lens. This magnifier's innovative features provide a spacious working platform suitable for any application. Mounting clamp provides uncompromised workspace due to its sturdy, slim design. The magnification lens is illuminated with shadow-free full or half ring optimum bright LEDs.

Magnification: 2.5x
 Diopter: 6D
 Lens size: 76 mm
 Lens shape: Aspheric
 Working distance: Variable
 Lens material: PXM® lightweight lens with patented Ceratec® scratch resistant coating
 Illumination: SMD LED
 Power source: 120 V & 230 V

No. 28015-25



Eschenbach Scribolux Magnifier

This magnifier provides an illuminated platform suitable for any working condition. The open design allows for a spacious working platform. Supplied in a microfiber pouch for protecting and cleaning the lens.

Magnification: 2.8x
 Diopter: 7/11D
 Lens size: 100 x 75 mm
 Lens shape: Aspheric
 Working distance: 7,5 cm (3")
 Lens material: PXM® lightweight lens with patented Ceratec® scratch resistant coating
 Illumination: SMD LED
 Power source: 6V (4 AA-Batteries included)

No. 28020-28



Optical Cleaning Kit

This convenient kit contains everything you need to clean lens surfaces safely. Perfect for microscopes, camera lenses, binoculars, telescopes, graphic art optics and all other fragile lenses. Storage case included.

Kit includes:

- 1 Bottle of lens cleaner (30 ml)
- 1 Ultra soft duster brush
- 1 Cleaning cloth (20 x 20 cm)
- 3 Books of lens paper (25 sheets each)



No. 29000-10

Lens Paper

This premium grade optical lens tissue is extremely soft and safe for any glass or plastic optical lens surface.



15 x 10 cm
Book of 50 sheets

No. 29015-50

Eschenbach mobilux® DIGITAL inspection

The reflection-free and high-contrast 4.3-inch display ensures relaxed work. The HD camera arranged centrally under the display enables easy orientation. A magnification of up to 15x can be selected continuously or in increments by touching the magnifying glass symbol. The integrated LED lighting offers great variability in lighting and exposure settings for a wide variety of applications. The mobilux® offers measurement and comparison functions via adjustable scales and templates as well as simultaneous comparison measurements of the target and actual status via a split screen on the PC.

With the photo function, the live image seen through the magnifying glass can be saved as a photo on an inserted SD card. The images can also be easily transferred to a computer via a USB connection. In addition, the USB connection to the computer enables the live image of the magnifying glass to be transferred to the PC monitor, so the mobilux® can also be used as a screen reader. The "mobilux® digital" program supplied must first be installed on the computer (Windows Vista, Windows 7, 8 or Windows 10).

Delivery incl. USB cable length 2m, SD memory card (incl. software), hand strap, manual, case for storage, calibration plate. Mains adapter for EU, GB, US, AUS included.



Magnification: 4 -15x
 Field of view: Variable
 Working distance: Variable
 Screen size: 11 cm (4.3")
 Screen resolution: 480 x 272 px
 User input: Touchscreen

No. 28070-50

Eschenbach laboCOMFORT

With the laboCOMFORT, both hands remain free to work. The screen can be folded up when not in use. Various locking options for individual height adjustment of the magnifying screen. The headband magnifier can also be used by people who wear glasses.



Can be used with the Eschenbach
 Clip-On LED light.

Magnification: 3x
 Working distance: 13 cm (5")

No. 28030-13

STUDENT INSTRUMENTS

Scissors 200 – 204

Cutters 205

Scalpel Handles 206

Forceps 207 – 212

Hemostats, Artery Clamps,
Pin & Needle Holders, Retractors,
Vessel Dilators & Clamps 213 – 221

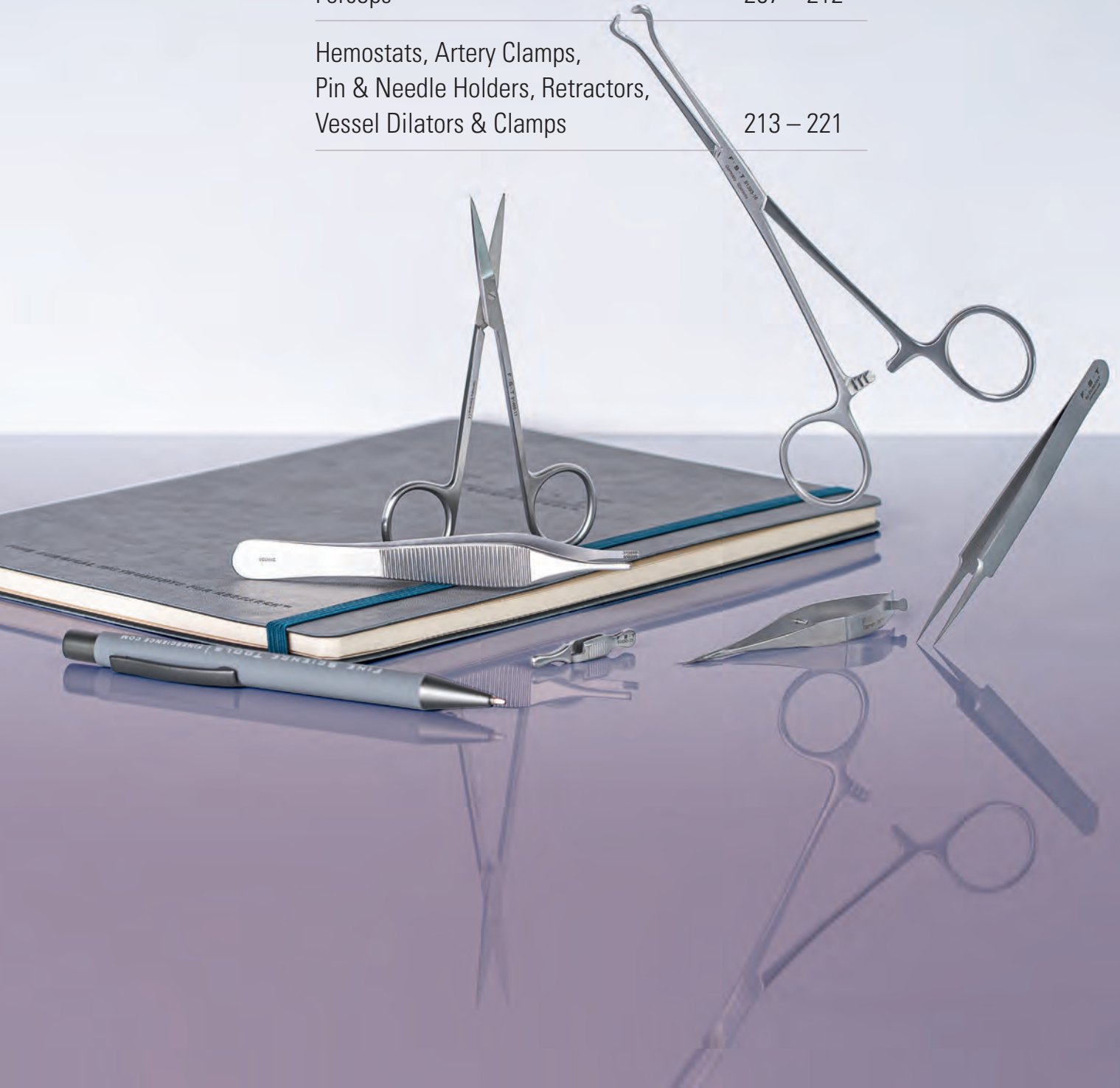

FST STUDENT QUALITY INSTRUMENTS



FEATURES:

- Economy
- Quantity discounts
- Quality
- Less hand finishing
- Less expensive alloys

One of the hallmarks of FST has always been to accurately assess the needs of our customers. We gather information not only from the lab, but from conferences, journals and researchers. Whether it is designing new tools or finding new applications for existing instruments, we believe our best information comes directly from you.

Our customers wanted reduced costs and quantity discounts without sacrificing the precision and quality inherent in German instruments. To meet their needs, we have developed a full line of “student” instruments. They were created for use in the classroom where students are learning proper instrument care.

Unlike our competitors, the quality of these instruments does not drop dramatically with the price. Our student line uses quality stainless steel and maintains the precision you expect from FST. In addition they carry our unconditional satisfaction guarantee while being offered at a significantly reduced price.

Not intended as a substitute for our highest quality instruments, the student line may require extra care as the alloys used are more susceptible to corrosion. Visit our website at finescience.com for more information.



**Quantity discount
for student
instruments:**
5-9 = **5%**
10+ = **10%**
*Per item, selection
cannot be assorted
for discount.*

STUDENT LINE

SCISSORS

Vannas Spring Scissors

Ideal for introductory courses in microdissection. The manufacturer, material and general pattern are the same as our No. 15003-08 but with much of the costly hand finishing omitted.



91500-09



Fine Scissors



91460-11



Sanvenero



% DISCOUNT

Quantity discount for student instruments:
 5-9 = 5%
 10+ = 10%
 Per item, selection cannot be assorted for discount.



Straight Sharp/Sharp

9 cm
 Cutting edge: 5 mm
 Tip Ø: 0.35 mm

No. 91500-09



Curved Sharp/Sharp

9 cm
 Cutting edge: 5 mm
 Tip Ø: 0.35 mm

No. 91501-09



Straight Sharp/Sharp

11.5 cm
 Cutting edge: 16 mm

No. 91460-11



Curved Sharp/Sharp

11.5 cm
 Cutting edge: 16 mm

No. 91461-11



Straight Sharp/Sharp

14.5 cm
 Cutting edge: 22 mm

No. 91408-14

STUDENT

Surgical Scissors



Length (cm)	Cutting edge (mm)	Straight Sharp / Sharp	Straight Sharp / Blunt	Straight Blunt / Blunt
10.5	20	No. 91402-10	No. 91401-10	No. 91400-10
12	26	No. 91402-12	No. 91401-12	No. 91400-12
13	28	No. 91402-13	No. 91401-13	
14.5	30	No. 91402-14	No. 91401-14	No. 91400-14



Length (cm)	Cutting edge (mm)	Curved Sharp / Sharp	Curved Sharp / Blunt
12	26	No. 91405-11	No. 91404-12
13	28	No. 91405-13	No. 91404-13
14.5	30	No. 91405-14	No. 91404-14



DISCOUNT

Quantity discount for student instruments:
 5-9 = 5%
 10+ = 10%
 Per item, selection cannot be assorted for discount.

STUDENT

Wagner



Spencer Ligature



% DISCOUNT

Quantity discount for student instruments:
 5-9 = 5%
 10+ = 10%
Per item, selection cannot be assorted for discount.



Straight Sharp/Sharp

11.5 cm
 Cutting edge: 20 mm

No. 91468-12



Straight Sharp/Sharp

9 cm
 Cutting edge: 16 mm

No. 91476-09

STUDENT

Lister Scissors

Longer blunt blade prevents damaging tissue underneath skin without losing the cutting line.



Mayo

80% of actual size



DISCOUNT

Quantity discount for student instruments:
5-9 = 5%
10+ = 10%
Per item, selection cannot be assorted for discount.



**Angled to side
Blunt/Blunt**

14 cm
Cutting edge: 26 mm

No. 91413-14



**Angled to side
Blunt/Blunt**

18 cm
Cutting edge: 30 mm

No. 91413-18



**Angled to side
Blunt/Blunt**

20 cm
Cutting edge: 34 mm

No. 91413-20



**Curved
Sharp/Blunt**

14.5 cm
Cutting edge: 28 mm

No. 91409-15



**Straight
Blunt/Blunt**

17 cm
Cutting edge: 32 mm

No. 91410-17



**Curved
Blunt/Blunt**

17 cm
Cutting edge: 32 mm

No. 91411-17

STUDENT

Metzenbaum Baby

Metzenbaum



% DISCOUNT

Quantity discount for student instruments:
 5-9 = 5%
 10+ = 10%
Per item, selection cannot be assorted for discount.



**Curved
Blunt/Blunt**

14.5 cm
Cutting edge: 22 mm

No. 91419-14



**Straight
Blunt/Blunt**

14.5 cm
Cutting edge: 22 mm

No. 91416-14



**Curved
Blunt/Blunt**

18 cm
Cutting edge: 24 mm

No. 91417-18

STUDENT

Heavy Scissors



**Curved
Sharp/Sharp**

Heavy Blades
10.5 cm
Cutting edge: 20 mm

No. 91405-10

Bone Scissors

For cutting fine bone.



**Curved
Sharp/Sharp**

9 cm
Cutting edge: 14 mm

No. 91604-09



Bone Cutter



Angled 30°

11 cm
Cutting edge: 19.5 mm
Blue plastic handle

No. 91601-11



DISCOUNT **0%**

Quantity discount
for student
instruments:
5-9 = 5%
10+ = 10%
Per item, selection
cannot be assorted
for discount.

STUDENT

Scalpel Handle #4



For scalpel blades,
see page 73.

#4

13 cm

No. 91004-13

Standard Scalpel Handle #3



For scalpel blades,
see page 74.

#3

12 cm

No. 91003-12

% DISCOUNT

Quantity discount
for student
instruments:

5-9 = 5%

10+ = 10%

Per item, selection
cannot be assorted
for discount.

STUDENT

Dumont #5



**Standard
Straight**

11 cm
Inox
0.1 x 0.06 mm

No. 91150-20

Dumont #7



**Standard
Curved**

11 cm
Inox
0.17 x 0.1 mm

No. 91197-00

DISCOUNT

Quantity discount
for student
instruments:
5-9 = 5%
10+ = 10%
*Per item, selection
cannot be assorted
for discount.*

STUDENT

FINE FORCEPS

Fine Forceps Straight



Fine Forceps Broad Shanks



Fine Forceps Curved



Fine Forceps Angled



% DISCOUNT

Quantity discount for student instruments:
5-9 = 5%
10+ = 10%
Per item, selection cannot be assorted for discount.



Straight

11 cm
0.2 x 0.1 mm

No. 91115-10



Straight / Broad shanks

12 cm
0.2 x 0.2 mm

No. 91113-10



Curved

12 cm
0.2 x 0.2 mm

No. 91117-10



Angled

11 cm
0.2 x 0.2 mm

No. 91110-10

STUDENT

Feilchenfeld



**Serrated/Sharp
Straight**

9 cm
Tip Ø: 0.75 mm

No. 91139-09



**Serrated/Sharp
Straight**

11.5 cm
Tip Ø: 1 mm

No. 91139-12

Splinter Forceps



**Serrated
Straight**

10.5 cm
Tip Ø: 0.3 mm

No. 91156-11

DISCOUNT

Quantity discount
for student
instruments:
5-9 = 5%
10+ = 10%
Per item, selection
cannot be assorted
for discount.

STUDENT

Micro Adson



80% of actual size



Serrated

12 cm

Tip width: 0.7 mm

No. 91118-12



1x2 Teeth

12 cm

Tip width: 1.3 mm

No. 91119-12

Adson

Wide, strong grip with narrow tips.



80% of actual size



Serrated

12 cm

Tip width: 1.5 mm

No. 91106-12



1x2 Teeth

12 cm

Tip width: 1.5 mm

No. 91127-12

Adson-Brown



Shark teeth

12 cm

Tip width: 2.5 mm

No. 91162-12

Adson with Cross Serrations



**1x2 Teeth/
Cross-serrations**

12 cm

Tip width: 1.3 mm

No. 91427-12

% DISCOUNT

Quantity discount for student instruments:
5-9 = 5%
10+ = 10%
Per item, selection cannot be assorted for discount.

STUDENT

Anatomical and Surgical Forceps

Broad pattern with strong spring action.

Anatomical Standard Pattern



Straight Serrated

Tip width (mm)	Length (cm)	Item
2.5	11.5	No. 91100-12
2.7	13	No. 91100-13
3	14.5	No. 91100-14
3.5	16	No. 91100-16
4	17	No. 91100-17



91100-12



Surgical Standard Pattern

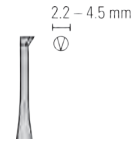

Straight 1x2 Teeth

Tip width (mm)	Length (cm)	Item
2.2	12	No. 91121-12
2.4	13	No. 91121-13
2.6	14.5	No. 91121-14
2.8	15.5	No. 91121-15
3	16	No. 91121-16
3.5	18	No. 91121-18
4	20	No. 91121-20
4.5	25	No. 91121-25

Anatomical Narrow Pattern



Straight Serrated

Tip width (mm)	Length (cm)	Item
1.5	11.5	No. 91102-12
2.1	13	No. 91102-13
2.2	14.5	No. 91102-14
2.3	16	No. 91102-16

Surgical Narrow Pattern



Straight 1x2 Teeth

Tip width (mm)	Length (cm)	Item
2	11.5	No. 91123-12
2.2	14.5	No. 91123-14
2.4	16	No. 91123-16



Quantity discount for student instruments:
 5-9 = 5%
 10+ = 10%
 Per item, selection cannot be assorted for discount.

STUDENT

Semken



Serrated Straight

11.5 cm
Tip width: 1.2 mm

No. 91108-12

Straight

14.5 cm
Tip width: 2.2 mm

No. 91108-14

Gillies



80% of actual size

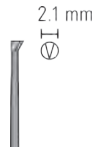

1x2 Teeth and Cross-Serrations

15.5 cm
Tip width: 2.1 mm

No. 91128-15

Russian



5.7 mm



Serrated

15 cm
Tip dimension: 7.6 x 5.7 mm

No. 91126-15

McIndoe



Serrated

15 cm
Tip width: 1.2 mm

No. 91138-15

% DISCOUNT

Quantity discount for student instruments:
5-9 = 5%
10+ = 10%
Per item, selection cannot be assorted for discount.

STUDENT

Halsted-Mosquito



**Straight
Serrated**

12.5 cm
Tip width: 1.4 mm

No. 91308-12



**Curved
Serrated**

12.5 cm
Tip width: 1.4 mm

No. 91309-12



**Curved
1x2 Teeth and
Serrations**

12 cm
Tip width: 2 mm

No. 91331-12

Hartmann



**Curved
Serrated**

10 cm
Tip width: 1.5 mm

No. 91303-10

DISCOUNT

Quantity discount
for student
instruments:
5-9 = 5%
10+ = 10%
Per item, selection
cannot be assorted
for discount.

STUDENT

Crile



80% of actual size



Straight Serrated

14 cm
Tip width: 1.5 mm

No. 91304-14



Curved Serrated

14 cm
Tip width: 1.5 mm

No. 91305-14

Straight Serrated

16 cm
Tip width: 2 mm

No. 91304-16

Curved Serrated

16 cm
Tip width: 2 mm

No. 91305-16

Kelly



Straight Serrated

14 cm
Tip width: 2 mm

No. 91318-14



Curved Serrated

14 cm
Tip width: 2 mm

No. 91319-14

% DISCOUNT

Quantity discount for student instruments:
5-9 = 5%
10+ = 10%
Per item, selection cannot be assorted for discount.

STUDENT

Rochester-Pean

Pean



80% of actual size



Straight Serrated

14 cm
Tip width: 2 mm

No. 91316-14



Curved Serrated

14 cm
Tip width: 2 mm

No. 91317-14

Straight Serrated

16 cm
Tip width: 2.5 mm

No. 91316-16

Curved Serrated

16 cm
Tip width: 2.5 mm

No. 91317-16



Straight Serrated Narrow

14 cm
Tip width: 2 mm

No. 91322-14



Curved Serrated Narrow

14 cm
Tip width: 2 mm

No. 91323-14

DISCOUNT

Quantity discount for student instruments:
5-9 = 5%
10+ = 10%
Per item, selection cannot be assorted for discount.

STUDENT

Ochsner-Kocher

Kocher



80% of actual size



Straight
1x2 Teeth and Serrations

14 cm
Tip width: 2.2 mm

No. 91328-14



Curved
1x2 Teeth and Serrations

14 cm
Tip width: 2.2 mm

No. 91329-14

Straight
1x2 Teeth and Serrations

16 cm
Tip width: 3 mm

No. 91328-16

Curved
1x2 Teeth and Serrations

16 cm
Tip width: 3 mm

No. 91329-16



Straight
1x2 Teeth and Serrations
Narrow

14 cm
Tip width: 2.2 mm

No. 91330-14



Curved
1x2 Teeth and Serrations
Narrow

14 cm
Tip width: 2.2 mm

No. 91331-14

% DISCOUNT

Quantity discount for student instruments:
5-9 = 5%
10+ = 10%
Per item, selection cannot be assorted for discount.

STUDENT

Backhaus Towel Clamp



Tohoku Towel Clamp



Round and sharp tips

9 cm

No. 91195-09



Round and sharp tips

11 cm

No. 91195-11



Round and sharp tips

13 cm

No. 91195-13



Round and serrated tips

10 cm
Tip width: 2.5 mm

No. 91194-10



Round and serrated tips

13 cm
Tip width: 3 mm

No. 91194-13

DISCOUNT

Quantity discount for student instruments:
5-9 = 5%
10+ = 10%
Per item, selection cannot be assorted for discount.

STUDENT

Lorna Towel Clamp

Babcock



% DISCOUNT

Quantity discount for student instruments:
 5-9 = 5%
 10+ = 10%
Per item, selection cannot be assorted for discount.



Serrated

13 cm
 Tip width: 7 mm

No. 91196-13



Serrated

16 cm
 Tip width: 6 mm

No. 91393-16

STUDENT

Allis Clamp

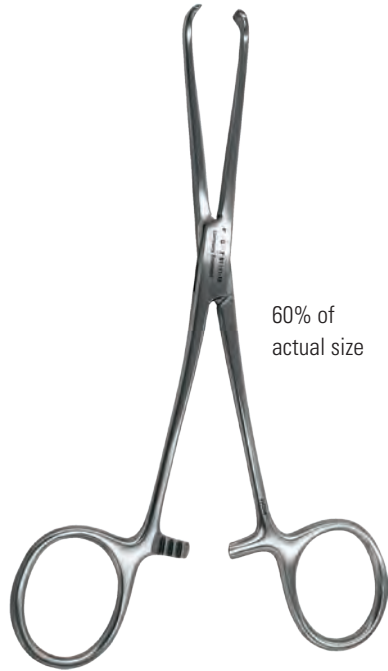

60% of actual size

5x6 Teeth

15 cm
Tip width: 6 mm

No. 91191-15

Hose Clamp



60% of actual size

Cross-Serrated

15 cm
Tip width: 4 mm

No. 91198-15

Lister Sine Clamp



60% of actual size

Serrated

16 cm
Tip width: 3 mm

No. 91199-16

DISCOUNT

Quantity discount for student instruments:
5-9 = 5%
10+ = 10%
Per item, selection cannot be assorted for discount.

STUDENT

Pin Holder



% DISCOUNT

Quantity discount for student instruments:
 5-9 = 5%
 10+ = 10%
 Per item, selection cannot be assorted for discount.

For pins, see page 115.

Nickel-plated

7.5 cm
 Jaw opening: 0-1 mm

No. 91606-07

Halsey



80% of actual size

For suture needles, see page 150-151.



Straight

13 cm
 Tip width: 1.5 mm
 Clamping length: 18 mm
 Lockable: Yes
 Scissors: No

No. 91201-13

Mayo-Hegar



80% of actual size

For suture needles, see page 150-151.



Straight

16 cm
 Tip width: 2.6 mm
 Clamping length: 21 mm
 Lockable: Yes
 Scissors: No

No. 91204-16

STUDENT

Senn-Miller



16 cm

3 sharp teeth 7 x 8 mm and
1 blunt tooth 18 x 6 mm

No. 91790-16



16 cm

3 sharp teeth 7 x 8 mm and
1 blunt tooth 18 x 6 mm

No. 91791-16

Vessel Dilator



Angled 10°

11 cm

Tip Ø: 0.3 mm

No. 91815-11

Spring-Loaded Retractor



Atraumatic blades
8.5 cm
Maximum spread: 3 cm

No. 91706-05

Barraquer

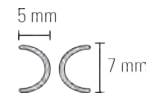

3 cm
Maximum spread: 1.1 cm

No. 91700-03

Dieffenbach



Straight

35 mm
Strong pressure

No. 91850-35

DISCOUNT 0%

Quantity discount
for student
instruments:
5-9 = 5%
10+ = 10%
Per item, selection
cannot be assorted
for discount.

STUDENT

NUMERICAL INDEX

00071-14	119	10035-00	72	10110-05	69	11003-12	105	11042-08	98	11200-14	88
00072-14	119	10035-05	72	10110-07	69	11003-13	105	11043-08	98	11200-33	87
00108-11	94	10035-10	72	10130-05	141	11003-14	105	11049-10	99	11203-23	87
00109-11	94	10035-12	72	10130-10	141	11003-16	105	11050-10	99	11203-25	87
00125-11	124	10035-15	72	10130-20	141	11003-18	105	11051-10	99	11210-10	87
00126-11	124	10035-20	72	10140-01	131	11003-20	105	11052-10	99	11210-20	87
00272-13	96	10035-25	72	10140-02	131	11006-12	103	11053-10	99	11215-01	57
00276-13	124	10035-30	72	10140-03	131	11006-15	97	11054-10	99	11215-02	57
00325-00	118	10050-00	71	10140-04	131	11008-13	106	11055-10	99	11220-21	86
00396-01	118	10052-11	71	10152-30	68	11008-15	106	11062-10	100	11223-20	86
00398-02	118	10053-09	71	10157-13	68	11009-13	106	11063-07	96	11229-08	88
00400-03	118	10053-13	71	10157-15	68	11009-15	106	11064-07	98	11229-10	88
00574-11	127	10055-12	66	10157-18	68	11010-17	111	11065-07	98	11231-20	84
00608-11	127	10056-12	66	10160-13	133	11011-17	111	11066-07	98	11231-30	84
00632-11	94	10058-15	67	10162-12	129	11012-18	111	11067-07	98	11241-30	86
00649-11	94	10059-13	66	10165-11	132	11012-21	111	11069-08	98	11242-40	86
10000-10	76	10059-15	67	10166-11	132	11012-25	111	11070-08	98	11251-10	81
10000-11	76	10060-00	76	10167-11	132	11013-18	111	11071-10	100	11251-20	81
10000-15	76	10060-13	76	10290-13	133	11013-21	111	11072-11	102	11251-21	82
10002-00	75	10061-12	131	10315-12	72	11014-18	110	11073-10	101	11251-23	81
10002-50	75	10062-12	131	10316-14	72	11015-18	110	11074-02	101	11251-30	81
10003-12	74	10063-15	130	10317-14	72	11016-17	111	11075-00	101	11251-33	83
10003-13	74	10064-14	131	10318-14	72	11017-17	111	11076-15	106	11251-35	83
10004-13	73	10065-15	130	10321-08	139	11018-12	103	11080-02	110	11252-00	79
10006-12	77	10066-15	130	10360-13	139	11019-12	103	11083-07	95	11252-20	81
10007-12	75	10073-14	66	10370-13	67	11020-12	103	11084-07	95	11252-21	82
10007-16	75	10075-16	65	10370-17	139	11021-12	108	11090-09	95	11252-23	81
10009-13	73	10080-05	65	10370-18	139	11021-14	108	11090-10	95	11252-30	81
10010-00	74	10081-10	65	10370-19	139	11021-15	108	11091-15	117	11252-40	81
10010-10	77	10082-15	65	11000-12	105	11022-12	103	11092-12	117	11252-50	79
10011-00	74	10083-20	65	11000-13	105	11022-14	108	11093-10	95	11253-10	82
10011-10	77	10087-12	135	11000-14	105	11022-15	108	11095-09	116	11253-20	80
10012-00	74	10088-15	133	11000-16	105	11023-10	108	11095-13	116	11253-21	80
10015-00	74	10089-11	135	11000-18	105	11023-12	108	11096-10	117	11253-25	80
10015-10	77	10090-13	134	11000-20	105	11023-14	108	11096-13	117	11253-27	83
10020-00	73	10090-17	134	11000-25	105	11023-15	108	11101-09	102	11253-29	80
10021-00	73	10091-12	135	11000-30	105	11024-12	106	11103-09	102	11254-20	79
10022-00	73	10092-12	136	11001-12	105	11024-18	111	11106-09	102	11255-20	81
10023-00	73	10093-13	136	11001-13	105	11025-18	111	11150-10	99	11258-20	88
10025-23	70	10094-13	136	11001-14	105	11026-15	109	11151-10	99	11260-20	84
10025-43	70	10095-12	65	11001-16	105	11027-12	103	11152-10	99	11270-20	85
10025-44	70	10096-16	65	11001-18	105	11028-15	109	11153-10	99	11271-30	85
10025-45	70	10097-16	65	11001-20	105	11029-14	108	11154-10	99	11272-30	85
10025-50	70	10098-06	137	11002-12	105	11030-12	104	11155-10	99	11272-40	85
10025-70	185	10099-12	138	11002-13	105	11031-15	109	11158-10	99	11272-50	85
10025-71	185	10099-15	138	11002-14	105	11032-12	103	11159-10	99	11273-20	80
10030-13	130	10100-30	70	11002-16	105	11036-20	111	11160-10	99	11273-22	80
10031-13	130	10100-45	70	11002-18	105	11036-90	111	11200-00	169	11274-20	85
10032-13	130	10110-01	69	11002-20	105	11040-08	98	11200-10	88	11280-11	127
10033-13	130	10110-03	69	11002-25	105	11041-08	98	11200-12	88	11281-11	127

11282-11	127	11972-20	90	12076-12	143	14003-13	45	14061-09	33	14116-18	49
11293-00	84	11980-13	90	12080-14	142	14003-14	45	14061-10	33	14117-14	49
11294-00	86	11988-01	90	12081-14	142	14003-16	45	14061-11	33	14117-18	49
11295-00	81	11988-02	90	12102-12	145	14003-18	45	14062-09	33	14130-17	46
11295-10	81	11988-03	90	12500-12	144	14003-20	45	14062-10	33	14131-14	47
11295-20	79	11990-14	89	12501-13	144	14004-12	45	14063-09	33	14160-10	33
11295-51	81	11991-14	89	12502-12	145	14004-13	45	14063-11	33	14161-10	33
11297-00	85	11992-12	89	12502-14	145	14004-14	45	14064-11	40	14171-10	44
11297-10	85	11992-20	90	12503-15	146	14004-16	45	14065-11	40	14173-12	41
11370-31	92	12001-13	144	12504-15	146	14004-18	45	14066-11	40	14184-09	31
11370-32	92	12002-12	145	12505-15	147	14005-12	45	14067-11	40	14185-09	31
11370-40	92	12002-14	145	12510-14	145	14005-13	45	14068-12	35	14200-21	51
11370-42	92	12003-15	146	12512-12	145	14005-14	45	14069-12	35	14370-22	34
11373-12	92	12004-16	146	12565-14	143	14005-16	45	14070-12	35	14370-23	34
11373-22	92	12004-18	146	13002-10	116	14007-14	46	14071-12	35	14501-14	46
11383-50	93	12005-15	147	13003-10	116	14008-14	45	14072-10	43	14502-14	46
11383-56	93	12010-14	145	13004-14	114	14010-15	50	14074-09	39	14504-14	46
11390-25	93	12018-12	151	13005-14	114	14010-17	50	14074-11	39	14505-14	46
11393-04	96	12020-00	153	13006-12	112	14011-15	50	14075-09	39	14508-15	48
11393-05	96	12020-09	153	13007-12	112	14011-17	50	14075-11	39	14509-15	48
11399-80	92	12022-09	153	13008-12	113	14012-15	51	14076-09	42	14510-15	50
11399-87	92	12022-19	153	13009-12	113	14012-17	51	14077-09	40	14510-17	50
11412-11	91	12023-00	153	13010-12	113	14013-15	51	14077-10	40	14511-15	50
11413-11	91	12028-12	151	13011-12	113	14013-17	51	14078-10	38	14511-17	50
11445-12	91	12029-12	151	13012-12	113	14014-17	51	14079-10	38	14512-15	50
11480-11	91	12030-01	152	13013-14	115	14015-17	51	14080-11	43	14512-17	50
11485-11	91	12030-04	152	13014-14	115	14016-14	49	14081-09	42	14518-14	48
11487-11	91	12030-20	152	13015-14	115	14016-18	49	14082-09	42	14518-18	48
11506-12	103	12030-22	152	13018-14	114	14017-14	49	14083-08	31	14519-14	48
11515-02	57	12030-23	152	13019-14	114	14017-18	49	14084-08	31	14519-18	48
11602-14	105	12035-00	152	13020-12	112	14018-13	48	14084-09	31	14531-09	47
11602-16	110	12040-01	151	13021-12	112	14018-14	48	14085-08	31	14558-09	37
11608-15	106	12040-02	151	13108-12	113	14018-18	48	14085-09	31	14558-11	37
11616-15	104	12040-03	151	13109-12	113	14019-13	48	14086-09	43	14559-09	37
11617-12	104	12050-01	149	14000-12	45	14019-14	48	14088-10	34	14559-11	37
11626-11	83	12050-02	149	14000-13	45	14019-18	48	14090-09	32	14568-09	36
11627-12	104	12050-03	149	14000-14	45	14024-14	49	14090-11	32	14568-12	36
11650-10	99	12050-10	149	14000-16	45	14028-10	38	14091-09	32	14569-09	36
11651-10	99	12050-20	149	14000-18	45	14029-10	38	14091-11	32	14569-12	36
11652-10	99	12052-08	148	14000-20	45	14037-10	44	14094-11	32	14574-09	39
11700-00	101	12052-09	148	14001-12	45	14040-10	35	14095-11	32	14574-11	39
11700-01	101	12052-10	148	14001-13	45	14041-10	35	14101-14	47	14575-09	39
11700-02	101	12052-11	148	14001-14	45	14054-13	46	14105-12	41	14575-11	39
11700-03	101	12060-01	142	14001-16	45	14058-09	36	14106-09	44	14958-09	37
11700-04	101	12060-02	142	14001-18	45	14058-11	36	14108-09	44	14958-11	37
11900-14	97	12061-01	142	14002-12	45	14059-09	36	14110-15	50	14959-09	37
11911-11	89	12061-02	142	14002-13	45	14059-11	36	14110-17	50	14959-11	37
11915-11	89	12074-12	143	14002-14	45	14060-09	33	14111-15	50	15000-00	19
11917-12	89	12075-12	143	14002-16	45	14060-10	33	14111-17	50	15000-01	22
11923-13	90	12075-14	143	14003-12	45	14060-11	33	14116-14	49	15000-02	22

NUMERICAL INDEX

15000-03	19	15396-00	21	16152-11	60	18000-52	173	18051-35	121	18090-46	173
15000-04	19	15396-01	21	16152-12	60	18004-18	181	18051-50	121	18090-50	173
15000-08	19	15400-12	23	16152-15	60	18004-23	181	18052-01	121	18090-51	173
15000-10	19	15401-12	23	16220-14	52	18004-27	181	18052-02	121	18105-01	184
15000-11	22	15403-08	20	16221-14	52	18004-50	181	18052-03	121	18105-04	184
15000-12	22	15404-08	20	17000-01	155	18010-00	182	18052-12	125	18106-01	184
15001-08	19	15514-12	26	17000-02	155	18010-01	182	18053-28	121	18131-12	124
15002-08	19	15610-08	22	17000-03	155	18010-02	182	18054-28	121	18132-12	124
15003-08	20	15615-08	22	17000-04	155	18019-00	182	18055-01	120	18144-30	121
15004-08	20	15617-08	22	17001-07	158	18019-01	182	18055-02	120	18155-13	100
15005-08	20	15650-11	27	17002-02	155	18019-02	182	18055-03	120	18196-10	184
15006-09	24	15651-11	27	17003-03	155	18020-00	149	18055-04	120	18200-01	161
15007-08	21	15750-11	23	17004-03	155	18020-01	149	18055-05	120	18200-02	161
15008-08	20	15751-11	23	17004-05	156	18020-02	149	18055-06	120	18200-03	161
15009-08	24	15903-08	20	17005-03	155	18020-03	149	18056-14	120	18200-04	161
15010-09	27	15904-08	20	17005-04	156	18020-20	149	18057-14	120	18200-05	161
15010-10	27	16000-14	55	17006-05	158	18020-30	149	18058-15	121	18200-06	161
15011-12	26	16001-15	53	17007-08	158	18020-40	149	18058-18	121	18200-07	161
15012-12	26	16002-18	54	17008-07	157	18020-50	149	18059-14	120	18200-08	161
15013-12	26	16004-16	55	17009-07	157	18020-60	149	18060-18	163	18200-09	161
15015-11	27	16005-16	55	17009-08	157	18020-70	149	18060-20	163	18200-10	161
15017-10	26	16015-17	53	17010-07	157	18025-10	96	18060-22	163	18200-11	161
15018-10	21	16016-17	53	17011-10	159	18026-10	97	18060-24	163	18200-12	161
15019-10	21	16020-14	52	17012-11	160	18030-30	149	18061-10	163	18200-20	161
15020-15	23	16021-14	52	17012-13	160	18030-40	149	18061-15	164	18200-50	161
15021-15	23	16022-15	54	17017-10	159	18030-50	149	18061-18	164	18320-11	121
15023-10	25	16023-15	54	17018-11	160	18030-60	149	18061-20	164	18374-43	121
15024-10	25	16025-14	63	17020-17	154	18030-70	149	18061-22	163	18374-44	121
15025-10	25	16030-12	60	17021-13	154	18030-80	149	18061-24	163	18403-11	127
15027-18	28	16030-16	60	17022-13	154	18035-01	184	18061-38	163	18406-11	127
15028-18	28	16044-10	60	17023-13	154	18035-02	184	18061-50	163	18406-13	127
15030-14	29	16050-15	61	17300-02	156	18035-03	184	18061-75	163	18555-01	120
15031-14	29	16060-11	64	17300-03	156	18035-05	184	18062-12	125	18555-02	120
15032-08	30	16101-10	58	17300-04	156	18035-35	184	18062-13	125	18555-03	120
15032-13	30	16102-11	58	17370-53	156	18035-50	184	18063-13	125	18555-04	120
15033-09	25	16104-14	62	18000-00	183	18035-80	184	18063-20	163	18601-15	107
15036-14	29	16104-19	62	18000-01	183	18036-19	184	18064-20	163	18602-15	107
15037-14	29	16105-16	62	18000-02	183	18036-22	184	18065-20	163	18603-14	107
15040-11	25	16106-14	62	18000-03	183	18036-24	184	18067-10	163	18961-15	164
15042-11	25	16107-14	56	18000-04	183	18038-45	121	18067-11	129	18961-17	164
15070-08	21	16109-14	56	18000-10	126	18039-45	121	18067-20	163	18961-18	164
15071-08	21	16120-14	52	18000-18	181	18040-00	123	18067-50	163	18961-20	164
15110-08	28	16121-14	52	18000-20	181	18040-11	118	18067-75	163	18961-75	164
15111-08	28	16130-15	61	18000-30	167	18040-14	119	18070-00	122	18961-85	164
15123-12	22	16140-11	59	18000-35	188	18040-22	118	18070-10	122	19003-00	190
15124-12	22	16141-11	59	18000-45	172	18040-33	118	18073-00	122	19003-01	190
15300-00	30	16142-11	59	18000-46	172	18050-28	121	18080-01	123	19007-05	181
15370-50	24	16143-12	59	18000-47	173	18050-35	121	18080-02	123	19007-07	181
15370-52	24	16144-13	59	18000-50	172	18050-50	121	18080-03	123	19007-09	181
15371-92	28	16150-24	63	18000-51	172	18051-28	121	18090-45	173	19007-14	181

19007-21	181	24202-13	167	28000-07	171	29070-07	170	91126-15	212	91401-14	201
19007-29	181	24202-14	167	28000-10	171	29070-08	170	91127-12	210	91402-10	201
19008-07	181	24202-15	167	28000-12	171	29070-09	170	91128-15	212	91402-12	201
19008-09	181	24202-16	167	28001-02	174	29071-01	170	91138-15	212	91402-13	201
19008-14	181	24212-01	166	28015-15	174	29071-02	170	91139-09	209	91402-14	201
19009-00	64	24212-02	166	28015-25	195	29071-03	170	91139-12	209	91404-12	201
19009-05	181	24213-02	166	28020-20	174	29071-04	170	91150-20	207	91404-13	201
19009-07	181	24213-12	166	28020-28	195	29071-05	170	91156-11	209	91404-14	201
19009-09	181	24214-02	166	28030-02	191	29071-06	170	91162-12	210	91405-10	205
19010-00	64	24215-02	165	28030-03	191	29071-08	170	91191-15	219	91405-11	201
19010-01	64	24220-00	168	28030-04	191	29071-09	170	91194-10	217	91405-13	201
19010-10	64	24221-10	168	28030-10	191	30051-10	185	91194-13	217	91405-14	201
19010-11	64	24221-50	168	28030-13	197	30076-14	185	91195-09	217	91408-14	200
20311-21	178	24221-90	168	28030-20	194	30085-15	187	91195-11	217	91409-15	203
20325-00	175	24916-01	165	28030-25	194	30085-30	187	91195-13	217	91410-17	203
20325-10	175	24916-02	165	28040-30	193	30087-00	188	91196-13	218	91411-17	203
20330-00	179	26000-25	141	28050-30	193	30087-20	188	91197-00	207	91413-14	203
20330-01	179	26000-30	141	28050-35	193	37500-00	186	91198-15	219	91413-18	203
20330-02	179	26000-35	141	28070-50	197	37500-05	186	91199-16	219	91413-20	203
20330-03	179	26000-40	141	28080-10	192	91003-12	206	91201-13	220	91416-14	204
20350-00	175	26000-45	141	28080-90	193	91004-13	206	91204-16	220	91417-18	204
20810-01	176	26000-50	141	29000-00	169	91100-12	211	91303-10	213	91419-14	204
20810-02	176	26000-55	141	29000-10	196	91100-13	211	91304-14	214	91427-12	210
20820-00	176	26000-60	141	29008-01	185	91100-14	211	91304-16	214	91460-11	200
20830-00	179	26000-65	141	29008-12	185	91100-16	211	91305-14	214	91461-11	200
20830-01	179	26000-70	141	29008-22	169	91100-17	211	91305-16	214	91468-12	202
20830-02	179	26001-25	141	29015-50	196	91102-12	211	91308-12	213	91476-09	202
20830-03	179	26001-30	141	29025-01	189	91102-13	211	91309-12	213	91500-09	200
20830-04	179	26001-35	141	29025-02	189	91102-14	211	91316-14	215	91501-09	200
20830-05	179	26001-40	141	29026-10	189	91102-16	211	91316-16	215	91601-11	205
20830-06	179	26001-45	141	29027-00	187	91106-12	210	91317-14	215	91604-09	205
20831-10	180	26001-50	141	29055-00	169	91108-12	212	91317-16	215	91606-07	220
20840-01	177	26001-55	141	29060-00	180	91108-14	212	91318-14	214	91700-03	221
20840-02	177	26001-60	141	29060-01	180	91110-10	208	91319-14	214	91706-05	221
20840-03	177	26001-65	141	29060-02	180	91113-10	208	91322-14	215	91790-16	221
20842-03	177	26001-70	141	29060-03	180	91115-10	208	91323-14	215	91791-16	221
20850-00	178	26002-10	141	29060-04	180	91117-10	208	91328-14	216	91815-11	221
20850-10	178	26002-15	141	29060-05	180	91118-12	210	91328-16	216	91850-35	221
20850-11	178	26002-20	141	29060-06	180	91119-12	210	91329-14	216		
23005-10	150	26003-15	141	29066-00	180	91121-12	211	91329-16	216		
24201-00	168	26007-01	141	29066-01	180	91121-13	211	91330-14	216		
24201-01	168	26007-02	141	29066-02	180	91121-14	211	91331-12	213		
24202-01	167	26007-03	141	29066-03	180	91121-15	211	91331-14	216		
24202-02	167	26007-04	141	29066-04	180	91121-16	211	91393-16	218		
24202-03	167	26007-05	141	29070-01	170	91121-18	211	91400-10	201		
24202-04	167	26016-12	140	29070-02	170	91121-20	211	91400-12	201		
24202-05	167	26018-17	140	29070-03	170	91121-25	211	91400-14	201		
24202-06	167	26029-10	102	29070-04	170	91123-12	211	91401-10	201		
24202-11	167	26030-10	102	29070-05	170	91123-14	211	91401-12	201		
24202-12	167	27000-01	190	29070-06	170	91123-16	211	91401-13	201		

A

Absorption swabs	184
Adson DeBakey Forceps	104
Adson Forceps	103, 210
Adson-Brown Forceps	104, 210
Adson-Graefe Forceps	104
Agricola Retractor	156
Allis Clamp Forceps	117, 219
Alm Retractors	157
Animal Identification	
Ear Punch	165 – 166
Ear Tags	168
Markers	167
Tattoo System	168
Autoclave Tape	174

B

Babcock Clamp	218
Baby-Beyer Rongeurs	54
Baby-Mixer Hemostat	115
Backhaus Towel Clamp	116, 217
Barraquer Retractors	221
BeeBee Bone Scissors	60
Beyer Rongeur	54
Biemer	
Clip Applicator	120
Clips	121
Spring Scissors	30
Bishop-Harman	98
Blair Retractor	154
Boehler Bone Cutter	61
Bone	
Austin Chisel	65
Dissecting Chisel	65
Forceps	64
Nipper	58
Scissors	205
Scraper	65
Screws	64
Spring Scissors	59
Wax	64
Bonn	
Forceps	95
Micro Probe	130
Scissors	31, 43
Bonn-Strabismus Scissors	31
Bowman Retractor	158
Breakable Scalpels	71
Bulldog Clamps	121

C

Calipers	188
Cannulation System	126
Carbon Steel Blades	72
Castroviejo	
Needle Holder	142 – 143
Spring Scissors	24 – 27
Surgical Caliper	188
Cataract Knife	66
Cauterizer	182 – 183

Ceramic	
Scalpel Handle	70
Scalpels	70, 185
Ceramic Coated	
Forceps	79, 85
Iris Scissors	37
Spring Scissors	23, 27
Circular Saw	181
Cleaning Brush	184
Cleveland Bone Cutter	62
Clipper II Spring Scissors	30
Clips (Vascular)	
Biemer	121
Bulldog Artery Spring Clamp	121
Bulldog Type Serrefines	121
Dieffenbach	221
Dietrich Bulldog	121
Double Clamps	118
Micro Serrefines	120
Mini Serrefines	121
S&T Micro	118
Schwartz Micro Serrefines	121
Titanium	120
Clock (Electronic Timer)	190
Cohan-Vannas Spring Scissors	22
Colibri Retractors	155 – 156
Combination Spatula and Probe	134
Combination Spatula and Spoon	134
Cover Glass Forceps	101
Crile Hemostats	114, 214
Crile-Wood Needle Holders	146
Cross-Action Forceps	101
Curettes	65
Cutters	57, 205
BeeBee Bone Scissors	60
Boehler Bone Cutter	61
Bone Nipper	58
Bone Pliers	63
Bone Scissors	60
Bone Shears	63
Bone Trimmers	56
Cartilage	56
Cleveland	62
Dumont	57
Liston Bone	62
Littauer Bone	60
Malleus Nipper	59
Skull Flap	61

D

DeBakey Forceps	106
Decapitation Scissors	51
Diamond Coated Forceps	89
Diamond Knives	70
Dieffenbach Clamp	221
Dietrich Bulldog Clamps	121
Double Micro Clamp Applying Forceps	119
Double Micro Clamps	118
Dowell Spring Scissors	25

Drill Accessories	
Burs	181
Circular Saw	181
Mandrel	181
Trephines	181
Dumont	57, 79 – 88, 127, 207

E

Ear Punches	165 – 166
Ear Tags	168
Episcleral Forceps	100
Eschenbach Magnifier	193 – 195, 197
Clip-on LED light	194

F

Feeding Needles	
Reusable	163
Single Use	164
Feilchenfeld Forceps	209
File Set	185
Fomon Retractor	154
Forceps	90 – 91
Adson	103
Adson (Student)	210
Adson DeBakey	104
Adson-Brown	104
Adson-Brown (Student)	210
Adson-Graefe	104
Allis Clamp Forceps	117
Allis Clamp Forceps (Student)	219
Balanced	107
Biemer Clip Applicator	120
Bishop-Harman	98
Bone	64
Bonn	95
Bonn Micro	95
Ceramic Coated	79, 85
Circle	102
Components	88
Cover Glass	101
Cover Slip	83
Cross Action	101
DeBakey Round Handled	106
Diamond Coated	89
Double Micro Clamp Applying	119
Dumont	79 – 88, 127
Dumont (Student)	207
Episcleral	100
Epoxy Coated	86 – 87
Feilchenfeld (Student)	209
Forceps Style Clip Applicator	120
Gerald	110
Gillies	109
Gillies (Student)	212
Gold Plated	89
Graefe	98 – 99
Insect Handling	102
Laminectomy	86
London	110

McIndoe (Student)	212
Micro Adson	103
Micro Adson (Student)	210
Micro-Blunted Tips	80
Mirror Finish	81, 90 – 91
Moria Bonn	93
Moria Iris	92
Moria Paufigue	93
Moria Suture Tying	96
Moria Ultra Fine	92
Mouse Handling	111
Narrow Pattern	105
O-Rings	169
Octagon	98
Organ Holding	109
Pierse Fixation	100
Plastic	101
Potts-Smith	111
Repair Kit	169
Replaceable Tips	90
Ring	102
Russian	109
Russian (Student)	212
S&T	94
S&T Micro Clamp Applying	119
S&T SuperGrip	94
S&T Suture Tying	96
S&T Vessel Cannulation	127
Self-Closing	91
Semken	106
Semken (Student)	212
Sliding Lock	83, 100
Sorensen	107
Splinter (Student)	209
Standard Pattern	105
Standard Pattern (Student)	211
Student	208
Suture Tying	95 – 97
Taylor	111
Tissue	108
Titanium	110
Vessel Cannulation	127
Vessel Dilators	124
Vessel Dilators (Student)	221
Vial	97
Vitro Grasping	97
Forceps Style Clip Applicator	120
Forceps with Replaceable Tips	90
Friedmann Rongeurs	55
Friedmann-Pearson Rongeurs	52

G

Galilean Loupes	193
Gavage Feeding Needles	163 – 164
Gelpi Retractor	159
GenoPunch	165
Gerald Forceps	110
Gillies Forceps	109, 212
Gold Plated Forceps	89
Gold Wire Contacts	190

Goldstein Retractors	155
Graefe Forceps	98 – 99
Graefe Scissors	44
Grooved Director	133
Gross Anatomy Blade and Handle	76
Gross Anatomy Knives	68
Gross Anatomy Probe	133
Guthrie Retractor	154

H

Halsey Needle Holder	144, 220
Halsted-Mosquito Hemostats	113, 213
Hartmann Hemostats	116, 213
Heavy Scissors	205
Heiss Retractor	159
Hemostats	112
Baby-Mixer	115
Crile	114
Crile (Student)	214
Halsted-Mosquito	113
Halsted-Mosquito (Student)	213
Hartmann	116
Hartmann (Student)	213
Kelly	114
Kelly (Student)	214
Kocher (Student)	216
Mosquito	113
Ochsner-Kocher (Student)	216
Peen (Student)	215
Providence-Hospital	115
Rochester-Peen (Student)	215
Ultra-fine	112
Hippocampal Dissecting Tool	138
Holders and Breakers	71
Hooks	130 – 131
Horizon™ Metal Ligation System	122
Hose Clamp	219
Hot Bead Sterilizer	172 – 173

I

Insect Handling Forceps	102
Insect Pins	141
Insert Pins	141
Instrument Care	
Double Tip Protectors	180
Forceps Repair Kit	169
Instrument Oil	169
Marking Tape	170
Sharpening Stones	169, 185
Tip Protectors	180
Instrument Cases	
Aluminum (Storage)	178 – 179
Plastic (Storage)	179
Sterilization	176 – 178
Instrument Oil	169
Iris Scissors	32 – 38, 200
Iris Spatula	136

K

Kalt Needle Holders	142
Kaye Scissors	44
Kelly Hemostats	114, 214
Kocher Hemostats	216

L

LaGrange Scissors	41
Large Loops Scissors	44
Lempert Rongeurs	55
Lens Paper	196
Lexer-Baby Scissors	38
Ligation Aids	125
Ligation Systems	122
Lister	
Scissors	47, 203
Sine Clamp	219
Liston Bone Cutter	62
Littauer Bone Cutter	60
London Forceps	110
Lorna Towel Clamp	117, 218
Luer Rongeurs	53

M

Magnifiers / Loupes	189, 191 – 195, 197
Cleaning Kit	196
Headband	193
Malleus Nipper	59
Mandrel	181
Markers	167
Marking Tape	170
Mathieu Needle Holder	145
Mayo Scissors	50, 203
Mayo-Hegar Needle Holder	146, 220
Mayo-Noble Scissors	51
Mayo-Stille Scissors	51
McIndoe Forceps	212
McPherson Forceps	96
Metzenbaum Baby Scissors	48, 204
Metzenbaum Scissors	48 – 49, 204
Michel Suture Clips & Applicators	151
Micro Clip Applicator	120
Micro Serrefines	120
Microsurgical Needles with Suture Thread	
Attached	148
Mini Serrefines	121
Minutien Pins	141
Moria	
Bonn Forceps	93
Bulldog Clamp	121
Forceps	92
Iris Scissors	34
Pascheff-Wolff Spring Scissors	28
Paufigue Forceps	93
Retractors	156
Spoons	139
Spring Scissors	21
Suture Tying Forceps	96
Vannas-Wolff Spring Scissors	24
Vessel Clamp	121

Mosquito Hemostats Micro	113
Mouse Handling Forceps	111
Multipurpose Forceps	107

N

Narrow Pattern Forceps	105
Needle Holders	
Castroviejo	142 – 143
Crile-Wood	146
Halsey	144
Halsey (Student)	220
Kalt	142
Mathieu	145
Mayo-Hegar	146
Mayo-Hegar (Student)	220
Olsen-Hegar	145
Ryder Mini	147
Tungsten Carbide	143 – 145, 147
Needles	
Etched Tungsten Micro Needles	141
Holders	140
Holders (Student)	220
Insect	141
Insert	141
Minutien	141
Suture Needles	149
Neuro Punches	184
Noyes Spring Scissors	26
Nylon Suture	149

O

O-Rings for Forceps	169
Obsidian Stone Age Scalpels	69
Ochsner-Kocher Hemostats	216
Octagon Forceps	98
Olsen-Hegar Needle Holder	145
Optical Cleaning Kit	196
Organ Holding Forceps	109

P

Pean Hemostats	215
Pearson Rongeurs	53
Pick	129
Pierse Fixation Forceps	100
Pin Holders	140, 220
Plastic Forceps	101
Potts-Smith Forceps	111
Probes	131
Bonn Micro Probes	130
Double Pronged Pick	129
Providence-Hospital Hemostats	115
PTFE Feeding Needles	164

R

Repair Kit	169
Retraction System	161

Retractors	154 – 156, 158, 221
Agricola	156
Alm	157
Barraquer (Student)	221
Blair	154
Bowman	158
Colibri	155 – 156
Fomon	154
Gelpi	159
Goldstein	155
Guthrie	154
Heiss	159
Senn-Miller (Student)	221
Weitlaner-Locktite	160
Wullstein	160
Reusable Feeding Needles	163
Ring Forceps	102
Rochester-Pean Hemostats	215
Rongeurs	
Baby-Beyer	54
Beyer	54
Friedmann	55
Friedmann-Pearson	52
Lempert	55
Luer	53
Pearson	53
Round Handled Needle Holders	143
Rulers	187
Russian Forceps	109, 212
Ryder Mini Needle Holder	147

S

S&T	
Clamp Applying Forceps	119
Forceps	94
Micro Clamps	118
SuperGrip Forceps	94
Suture Tying Forceps	96
Vessel Cannulation Forceps	127
Vessel Dilators	124
Sample Corers	184
Sanvenero Scissors	200
Scalpels	
Breakable	71
Cataract Knife	66
Ceramic Blade Cutter	185
Ceramic Blades	70
Circle Knife	67
Diamond Knives	70
Disposable Safety Scalpels	76
Holders and Breakers	71
Micro	72
Micro Knives	67, 72
Safety Scalpel Blade Cartridges	77
Scalpel Blade Remover	75
Scalpel Blades	73 – 74
Scalpel Handles	73 – 75, 77
Scalpel Handles (Student)	206
Schwartz Micro Serrefines	121

Scissors	
Bone	60
Bone (Student)	205
Bonn	31
Bonn Artery	43
Bonn-Strabismus	31
Decapitation	51
Dissector	42
Graefe	44
Heavy (Student)	205
Iris	32 – 38
Iris (Student)	200
Kaye	44
LaGrange	41
Large Loops	44
Lexer-Baby	38
Ligature	42
Lister	47
Lister (Student)	203
Mayo	50
Mayo (Student)	203
Mayo-Noble	51
Mayo-Stille	51
Metzenbaum	48 – 49
Metzenbaum (Student)	204
Metzenbaum Baby	48
Metzenbaum Baby (Student)	204
Micro	29
Moria Iris	34
Sanvenero (Student)	200
Shea	41
Spencer	42
Spencer (Student)	202
Stevens Tenotomy	40
Strabismus	39
Tissue Separating	43
Universal Scissors	186
Utility Scissors	186
Wagner	35
Wagner (Student)	202
Walton	40
Screwdriver	185
Semken Forceps	106, 212
Senn-Miller Retractors	221
Sharpening Stones	169, 185
Shea Scissors	41
Sichel Knife	66
Silicone Mat	175
Silk Sutures	149
Silver Neuro Clips	123
Single Use Feeding Needles	164
Skin Staplers & Applicators	152 – 153
Sliding Lock Forceps	100
Spatula	135, 137
Combination Probe and Spatula	134
Combination Spoon and Spatula	134
Spencer Ligature Scissors	42, 202
Spinal Cord Hook	129
Splinter Forceps	209
Spoons	139

Spring Scissors	23, 25, 27 – 28
Biemer	30
Bone Cutting	59
Castroviejo	24 – 27
Clipper II	30
Cohan-Vannas	22
Dowell	25
Micro	29
Moria	21, 24, 28
Noyes	26
Pascheff-Wolff	28
Titanium	22
ToughCut	22
Trident II	28
Tungsten Carbide	26
Vannas	19 – 24
Vannas (Student)	200
Vannas-Tübingen	20
Vannas-Wolff	24
Westcott	27
Stage Micrometers	189
Sterilization	
Containers	176 – 178
Disposable Wraps	174
Pouches	171
Tape	174
Stevens Tenotomy Scissors	40
Storage Cases	178 – 179
Strabismus Scissors	39
Surgical Scissors	45 – 47
Student	201
Tungsten Carbide	36 – 37, 39, 46 – 48, 50
Suture Needles	148 – 149
Suture Tying Forceps	95 – 97
Suturing Principles and Techniques in Laboratory Animals	150

T

Tattoo System	168
Taylor Forceps	111
Timer (Electronic)	190
Tip Protectors	180
Tissue Forceps	108
Tissue Separating Scissors	43
Titanium Forceps	110
Titanium Micro Point, Y-Hook, and Spatula	132
Tohoku Towel Clamp	217
Towel Clamps	
Backhaus	116
Backhaus (Student)	217
Lorna	117
Lorna (Student)	218
Tohoku (Student)	217
Travel Case for instruments	180
Trephines	181
Trident II Spring Scissors	28

V

Vannas Spring Scissors	19 – 24, 200
Vannas-Tübingen Spring Scissors	20
Vascular Occluders	123
Vessel Cannulation Forceps	127
Vessel Dilating Probe	133
Vessel Dilators	124, 221
Vial Forceps	97
VisorLIGHT™	191
Vitro Grasping Forceps	97
Von Graefe Knife	66

W

Wagner Scissors	35, 202
Walton Scissors	40
Weitlaner-Locktite Retractor	160
Westcott Spring Scissors	27
Wraps	174
Wullstein Retractor	160



Scissors, Bone Instruments,
Knives & Scalpels
pages 19 – 77



Forceps/Tweezers, Hemostats
& Vascular Instruments
pages 79 – 127



Probes, Needle Holders, Thread,
Retractors & Clamps
pages 129 – 161



Surgical & Laboratory
Accessories
pages 163 – 197



Student Quality Instruments
pages 199 – 121



Fine Science Tools (USA) Inc.

4000 East 3rd Avenue, Suite 100
Foster City, CA 94404-4824
USA

Telephone +1 800-521-2109 / +1 650-349-1636

Fax +1 800-523-2109 / +1 650-349-3729

E-Mail info@finescience.com

Web finescience.com



Fine Science Tools GmbH

Vangerowstraße 14
69115 Heidelberg
Germany

Telephone +49 62 21 - 90 50 50

Fax +49 62 21 - 90 50 590

E-Mail europa@finescience.de

Web finescience.de



2Biological Instruments

via L. Da Vinci 2C
21023 Besozzo VA
I-21023 ITALY

Telephone +39 0332 773210

E-Mail 2biol@2biol.com

Web www.2biol.com

